

Installation Instructions

-  polished
LU5800L
-  brushed
LU5800LBR

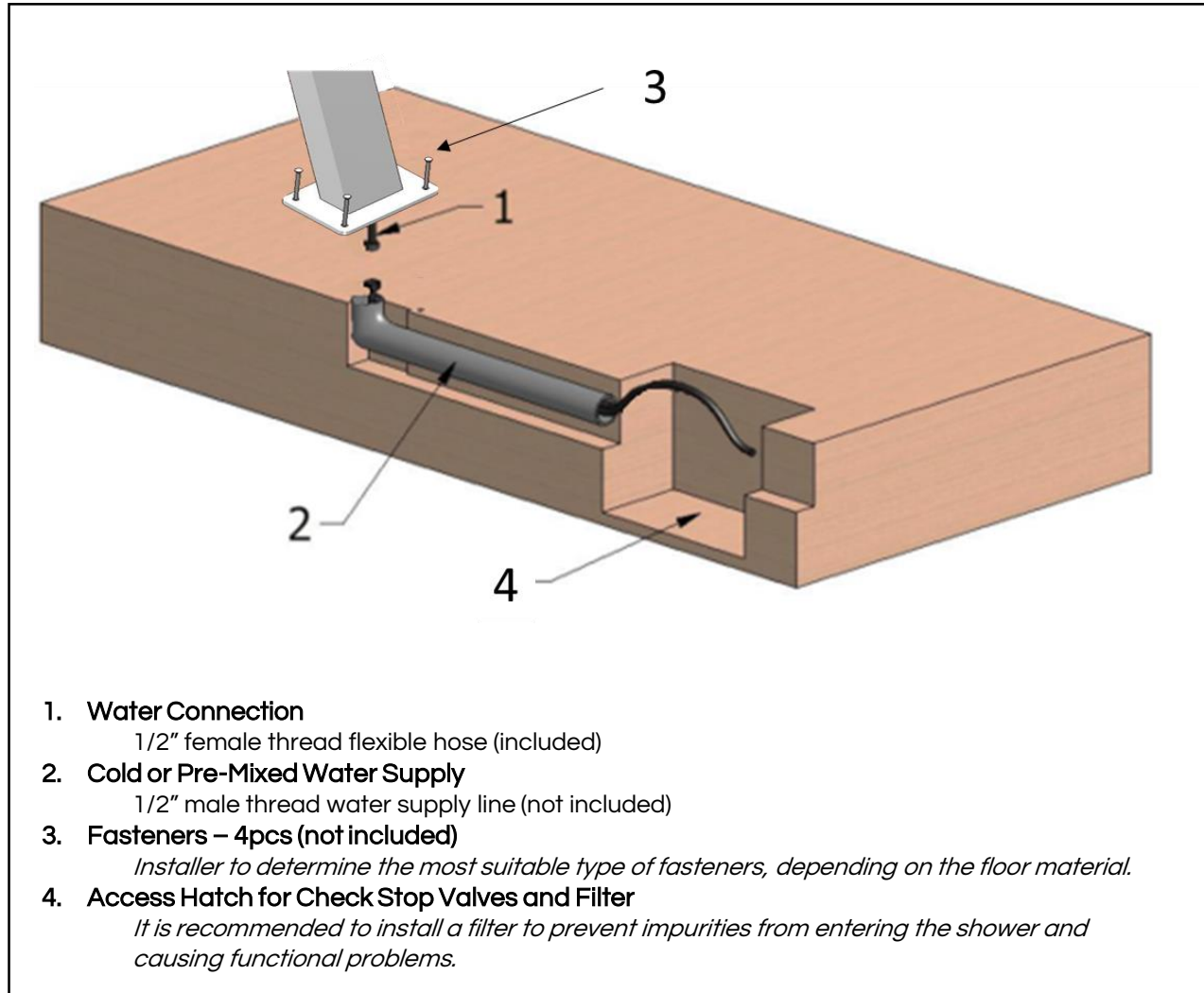

CLEANING

For routine cleaning, use a damp cloth with soap, rinse, and dry. Calcium spots can be avoided by drying after each use. Never use abrasive detergents or disinfectants containing alcohol, hydrochloric acid, or phosphoric acid. All shower heads are equipped with silicone nozzles. In order to prevent lime scales from clogging the shower head, periodically rub the silicone nozzles to free them of the lime deposits.

WINTERIZATION

We recommend disassembling the shower unit during the winter. Exposure to extreme frost may cause functional problems. If disassembly is not an option, we suggest to (1) fully drain the shower unit and supply lines, (2) remove the cartridge and shower head, and (3) cover the shower.

Optional Rough-In Bracket

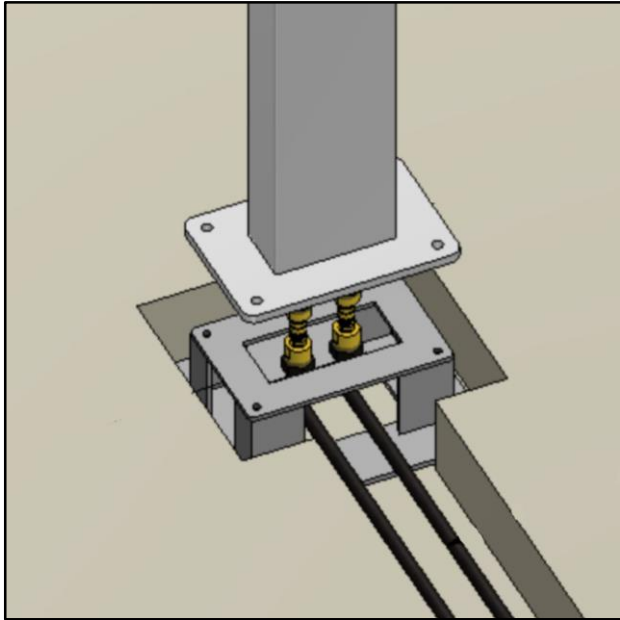

not included - order separately

item code **01-11-013**

