

Installation Instructions

-  polished
MR3700L
-  brushed
MR3700LBR
-  matte black
MR3700LMB

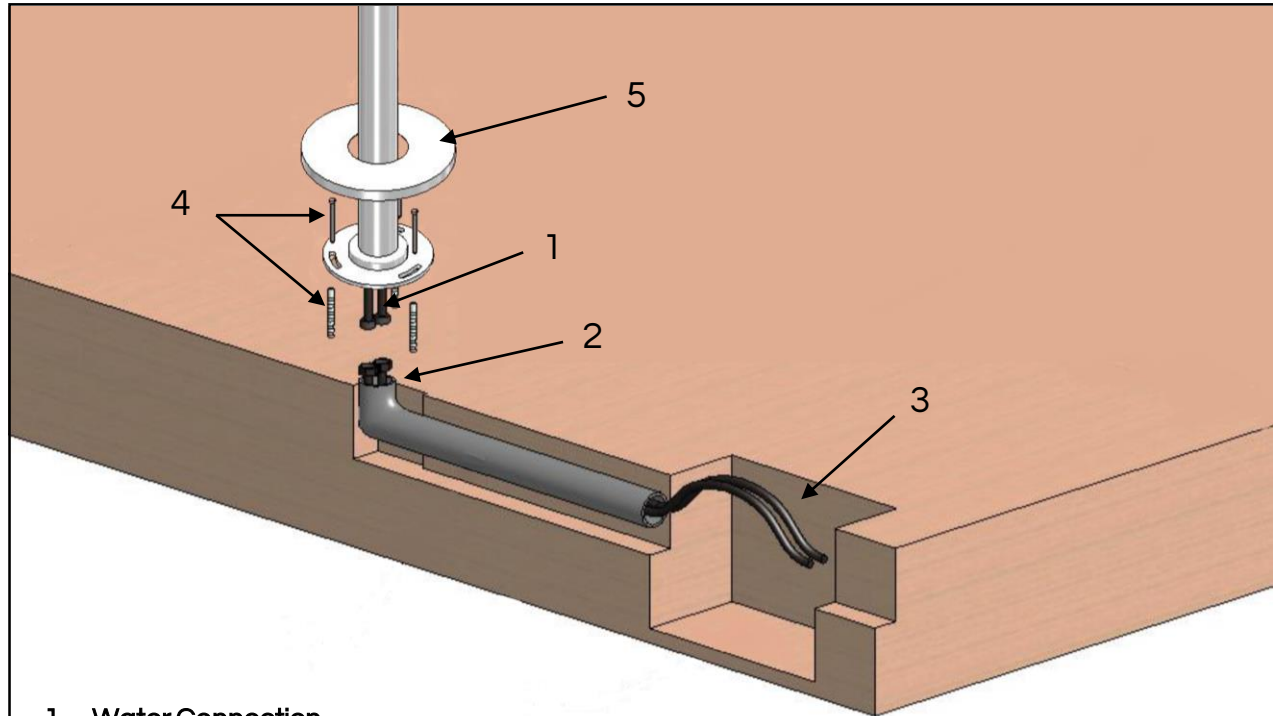

- 1. Water Connection**
1/2" female thread flexible hoses (included)
- 2. Hot & Cold Water Supplies**
1/2" male thread water supply lines (not included)
- 3. Access Hatch for Check Stop Valves and Filter**
It is recommended to install a filter to prevent impurities from entering the shower and causing functional problems.
- 4. Fasteners – 3pcs (not included)**
Installer to determine the most suitable type of fasteners, depending on the floor material.
- 5. Decorative Cover**

CLEANING

For routine cleaning, use a damp cloth with soap, rinse, and dry. Calcium spots can be avoided by drying after each use. Never use abrasive detergents or disinfectants containing alcohol, hydrochloric acid, or phosphoric acid. All shower heads are equipped with silicone nozzles. In order to prevent lime scales from clogging the shower head, periodically rub the silicone nozzles to free them of the lime deposits.

WINTERIZATION

We recommend disassembling the shower unit during the winter. Exposure to extreme frost may cause functional problems. If disassembly is not an option, we suggest to (1) fully drain the shower unit and supply lines, (2) remove the cartridge and shower head, and (3) cover the shower.

Optional Rough-In Bracket

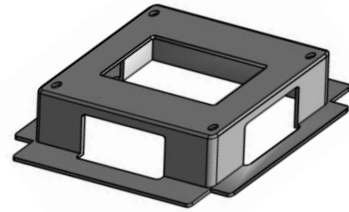
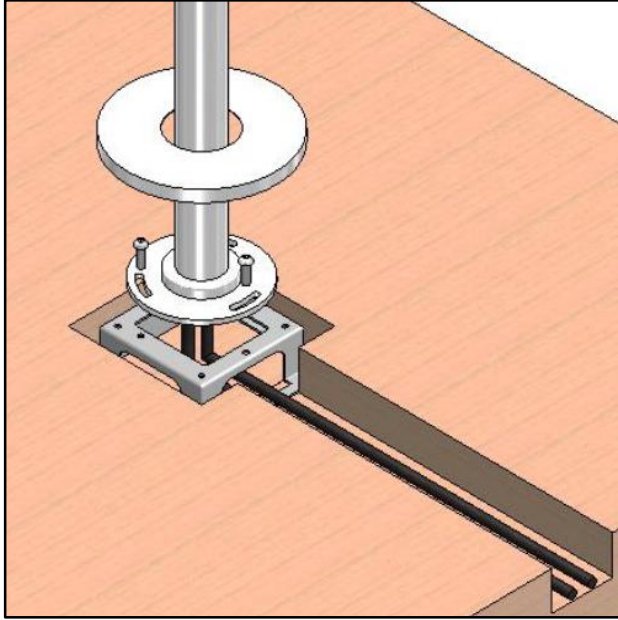

not included - order separately

item code **01-11-014**

