

MPRO Widespread Basin Faucet

US-PRO135-2

Installation Instructions

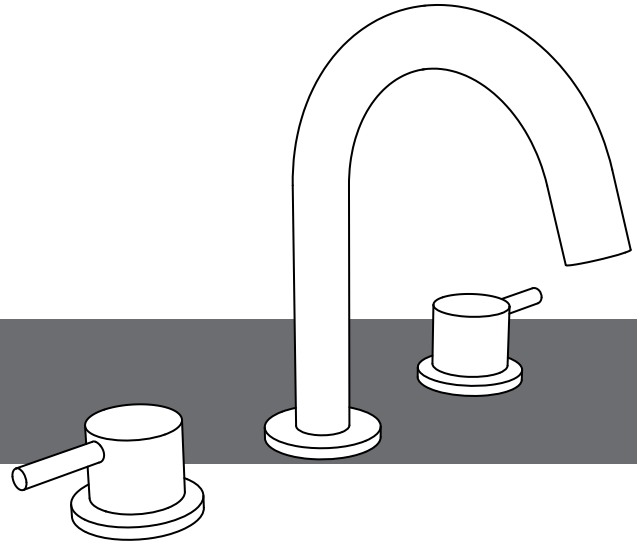

Introduction

The faucets in this range are single flow (hot and cold water mix in the body) and should therefore be supplied with hot and cold water at balanced pressures. If the faucets are not supplied at balanced pressures then the mixer will not function correctly.

The minimum water pressure required for these faucets is 20 psi. The maximum water pressure is 60 psi beyond which pressure-reducing valves must be installed.

The faucets are fitted with quarter-turn ceramic disc cartridges which provide a good flow rate with very smooth movement.

IMPORTANT: Please read these instructions carefully before you begin and retain for future reference. These instructions have been prepared for your guidance, you must exercise due care at all times.

Before beginning installation, check for any damage that may have occurred during transport.

We do not accept responsibility for any problems that may occur through incorrect installation.

Installation notes

The installation must comply with all plumbing codes including local codes and be installed by a licensed plumbing contractor.

Installing shut-off valves on incoming supply lines is recommended for ease of maintenance.

Turn off the main water supply before connecting to any existing pipework or doing any maintenance.

WARNING! Please check for any hidden pipes and cables, electric or otherwise, before drilling holes in a wall or floor.

Dimensions

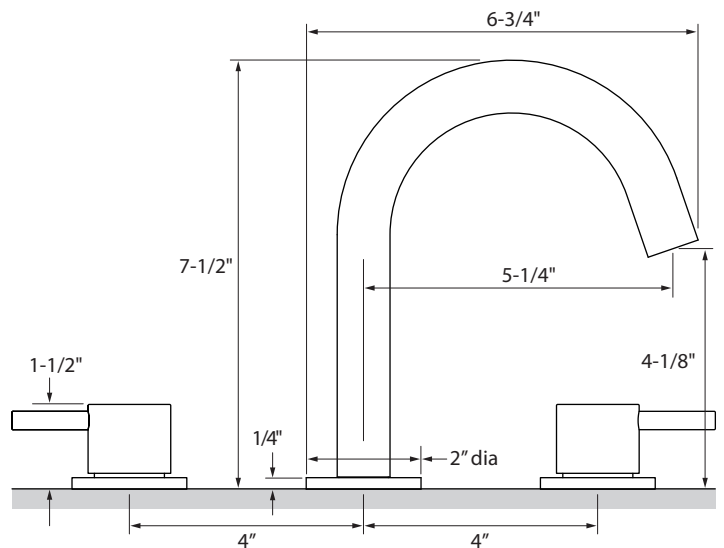

Flow rate

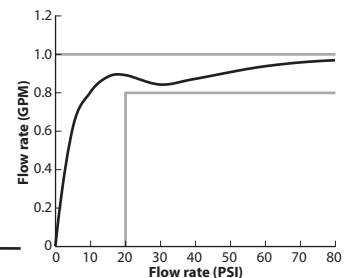

Tools required

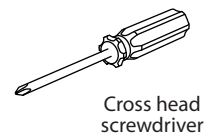
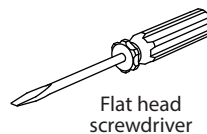
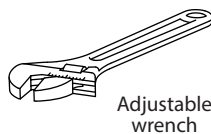
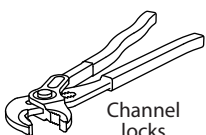

1 Installation

- Shut off the water heating system then, with the main water supply turned off, open the lowest hot and cold faucets and allow to drain until the pipes are empty.

Spout

- Screw the flexible pipes into the spout and fully hand tighten.
Be careful not to over tighten! The hot water should be connected to the left inlet when the faucet is viewed from the front.
- Pass the flexible pipes and threaded stud through the center hole in the counter/basin and place the spout into position.
- Slide the C-shaped black washer and then the C-shaped retaining plate up the flexible pipes and secure with the fixing nut, finger tight only.
- Check that the spout is positioned correctly and tighten the fixing nut. The spout needs to be fixed firmly but **do not** overtighten as damage may be caused to the counter/basin.

Valve bodies

- Both valve bodies must be fitted from the underside of the counter/basin, without the flanges fitted, making sure that the black nuts and washers are already screwed onto the valve body threads.
- The outlets of both valve bodies must be aligned so that the flexible pipes can supply water to the spout.
- Once this alignment is correct, the black nuts can be tightened to allow the flanges to be fitted from above to secure the valve body.
- Connect the valve bodies to the spout using the flexible pipes.
- Place the handle onto the cartridge spline and secure using a hexagonal key.
- The **hot** (to the left) and **cold** (to the right) water supplies can now be connected to the 1/2" NPSM fittings at the bottom of each valve body using compression fittings and washers supplied.

ATTENTION: Check all new connections for leaks.

- Turn on the main water supply, close all faucets except the new mixer and as the system refills, check for leaks.
- Once satisfied there are no leaks, switch on the heating system.

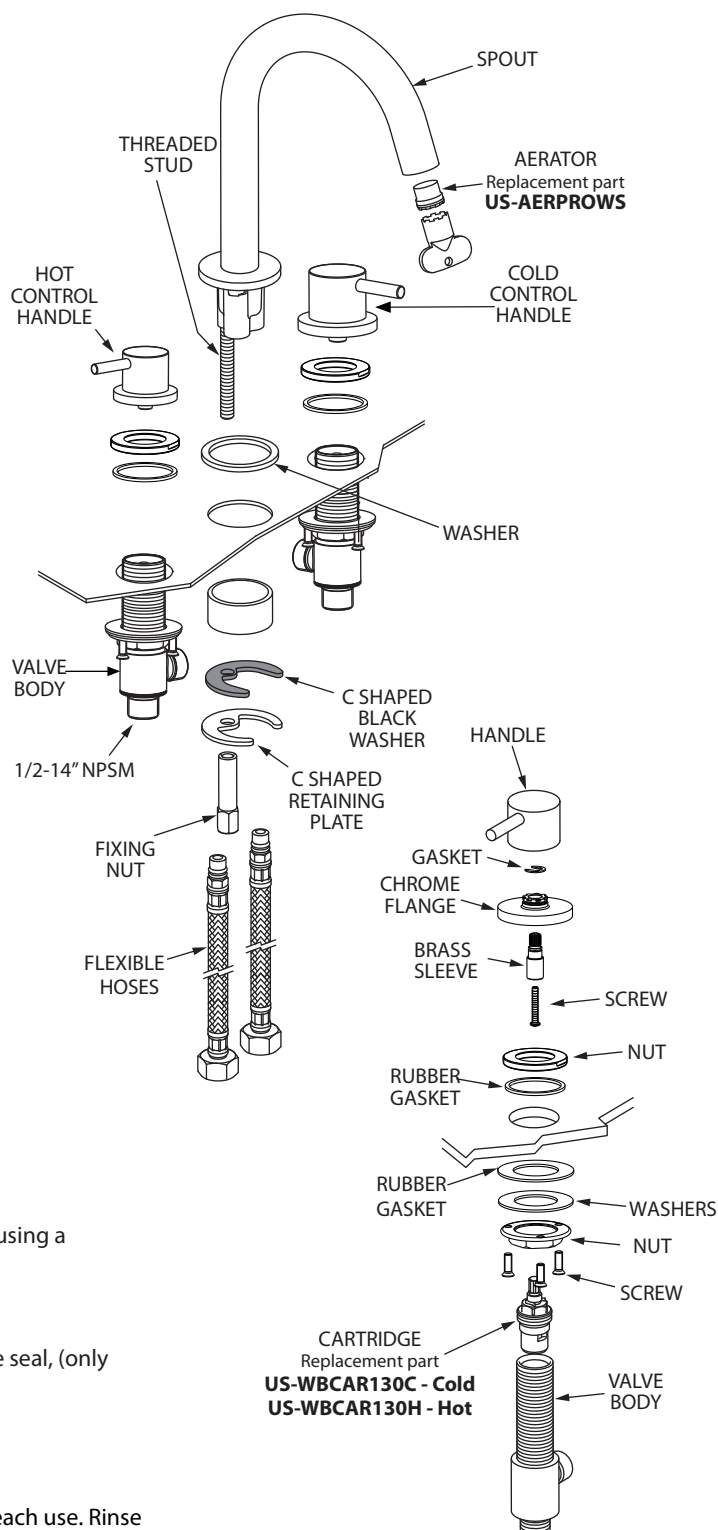

2 Maintenance

Cleaning the cartridge

- The concealed cartridge should give trouble-free service however servicing is a straightforward process.

To remove the cartridge

- With the water supply **turned off**, carefully remove the cover cap and using a hexagonal key loosen the screw but do not remove.
- Pull off the handle and unscrew the flanges.
- Using a 7/8" wrench, unscrew and remove the cartridge.
- Wash the cartridge with clean running water, dry and lightly grease the seal, (only use silicone grease).
- Replace the cartridge followed by the flange and handle.

3 Cleaning Instructions

Rinse away any traces of soap and gently dry with a clean, soft cloth after each use. Rinse completely with water and dry any overspray. This will maintain the finish and avoid water spotting.

To remove mineral deposits, use a 50/50 solution of white vinegar and water. Do not allow the solution to soak on the product.

Simichrome Polish® contains a protective film to enhance maintenance and is helpful in preventing water spot buildup. Follow instructions to ensure optimum results.

Never use an abrasive material such as a brush or scouring pad to clean the surface. The use of abrasive cleaners, cleansers or disinfectants will alter the surface finish and void the warranty. Do not allow certain materials such as toothpaste, cologne, shaving cream, nail polish remover, vinegar, wine, drain and glass cleaners to remain on the surface. Prolonged contact will alter surface finishes and void the warranty.

We DO NOT recommend using any household cleaners as many can cause damage to the finish.

Please see the website for care instructions for specific finishes.

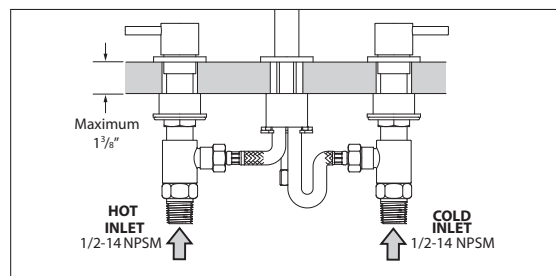

Warranty - This **Crosswater London** product is covered by a limited lifetime warranty. For full details, terms and conditions please visit our website.

For further information contact: **Crosswater London**, 393 Fortune Blvd., Milford, MA 01757

Toll free number: 844-XWATER-1 (844-992-8371) tel: 508-381-0433 fax: 508-381-6068

www.crosswaterlondon.com

email: technical@crosswaterlondon.com

Issue date: 15092019