

*ACCESSORIES PROGRAM
PROGRAMME DU ACCESSOIRES
PROGRAMA ACESORIOS*

RETTANGOLO

Accessories - Accessoires - Accesorios



Gessi SpA - Parco Gessi

13037 Serravalle Sesia (Vercelli) - Italy

Phone +39 0163 454111 - Facsimile +39 0163 459273

www.gessi.com - gessi@gessi.it

CAUTION - WARNING

- 1 - WARNING!!** PLEASE TAKE NOTICE THAT the product should never be used as a tool, hammer or for any purposes other than the one it has been designed for.

- 2 - WARNING!!** PLEASE TAKE NOTICE THAT the product should always be installed and tested by a professional plumber.

- 3 - WARNING!!** PLEASE TAKE NOTICE THAT electric cables should never be attached to the product as they may present a health and safety hazard.

- 4 - WARNING!!** PLEASE TAKE NOTICE THAT heavy objects should never be placed on or dropped on the product as they may damage the same and cause splinters, which may present a health and safety hazard.

- 5 - WARNING!!** PLEASE TAKE NOTICE THAT the instructions manual should carefully read before installation and the installation procedure provided therein must be properly followed and complied with.

- 6 - WARNING!!** PLEASE TAKE NOTICE THAT during installation the use of excessive force should be avoided in order to prevent damage to the product and/or its components and pieces. NEVER force a component or piece into another. NEVER force screws or over tighten screws.

ATTENTION - AVERTISSEMENT

- 1 - ATTENTION!!** NOUS VOUS PRIONS DE TENIR COMPTE QUE le produit ne doit jamais être utilisé comme outil, marteau ou pour tout autre but, autre que celui pour lequel il a été conçu.

- 2 - ATTENTION!!** NOUS VOUS PRIONS DE TENIR COMPTE QUE le produit doit être toujours installé et testé par un plombier professionnel.

- 3 - ATTENTION!!** NOUS VOUS PRIONS DE TENIR COMPTE QUE les câbles électriques ne doivent jamais être reliés au produit car ils pourraient représenter un danger pour la sécurité et la santé.

- 4 - ATTENTION!!** NOUS VOUS PRIONS DE TENIR COMPTE QUE les objets lourds ne doivent jamais être posés ou fait tomber sur le produit, car il peuvent provoquer la projection d'éclats et représenter un danger pour la sécurité et la santé.

- 5 - ATTENTION!!** NOUS VOUS PRIONS DE TENIR COMPTE QUE le manuel d'instructions doit être lu attentivement avant l'installation et que les procédures d'installation prévues ici doivent être adéquatement suivies et respectées.

- 6 - ATTENTION!!** NOUS VOUS PRIONS DE TENIR COMPTE QUE, pendant l'installation, il faut éviter l'emploi d'une force excessive de sorte à éviter des dommages au produit et/ou à ses composants et pièces. NE JAMAIS forcer un composant ou une pièce à l'intérieur d'une autre. NE JAMAIS forcer les vis et ne pas les serrer excessivement.

CUIDADO - ADVERTENCIA

- 1 - ¡CUIDADO!!** LES ROGAMOS QUE TENGAN EN CUENTA QUE nunca el producto no tiene que ser utilizado como en lugar de herramienta, martillos o para finalidades diferentes de aquellas para las cuales ha sido diseñado.

- 2 - ¡CUIDADO!!** LES ROGAMOS QUE TENGAN EN CUENTA QUE el producto tiene que ser instalado y ensayado siempre por un fontanero profesional.

- 3 - ¡CUIDADO!!** LES ROGAMOS QUE TENGAN EN CUENTA QUE nunca los cables eléctricos no tiene que ser conectado al producto ya que podrían representar un peligro para la seguridad y la salud.

- 4 - ¡CUIDADO!!** LES ROGAMOS QUE TENGAN EN CUENTA QUE nunca objetos pesados no tienen que ser apoyados o dejados caer sobre el producto ya que podrían causar la proyección de astillas y representar un peligro para la seguridad y la salud.

- 5 - ¡CUIDADO!!** LES ROGAMOS QUE TENGAN EN CUENTA QUE el manual de instrucción tiene que ser leído con cuidado antes de la instalación y que hay que cumplir adecuadamente con los procedimientos de instalación proporcionados.

- 6 - ¡CUIDADO!!** LES ROGAMOS QUE TENGAN EN CUENTA QUE, durante la instalación, hay que evitar el uso de una fuerza excesiva de manera que se puedan evitar daños del producto y/o componentes y piezas. NO fuercen NUNCA un componente o una pieza, la una dentro de la otra. NO fuercen NUNCA los tornillos y no los cierren excesivamente.

INSTALLATION - INSTALLATION - INSTALACIÓN

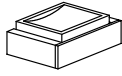

Art. 20801
Art. 20802

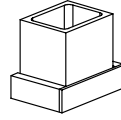

Art. 20807
Art. 20808

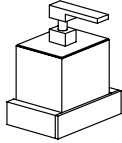

Art. 20813
Art. 20814

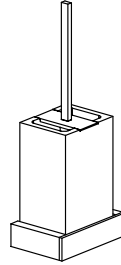

Art. 20819
Art. 20820

Fig. 1

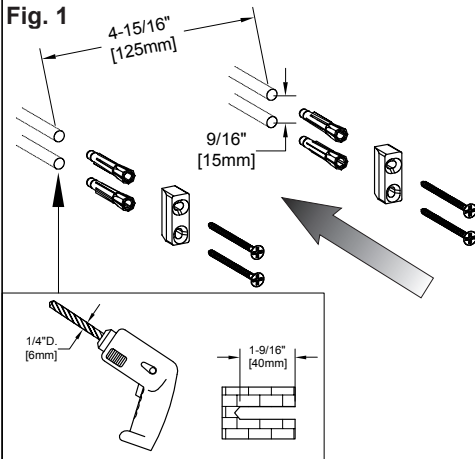

Fig. 2

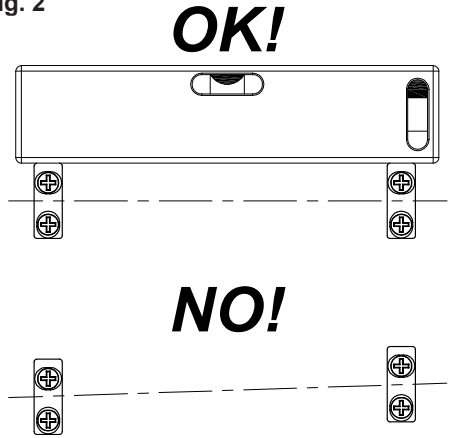

Fig. 3

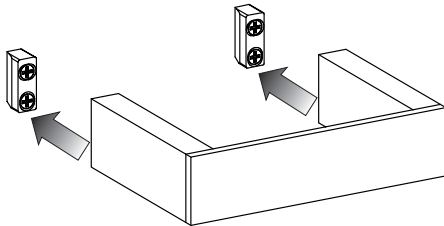
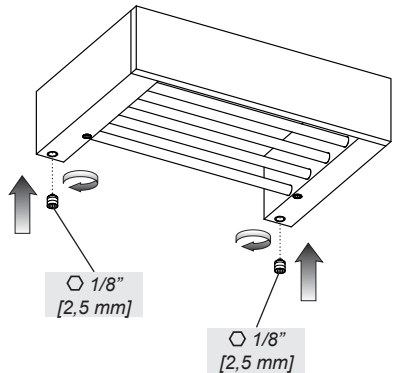
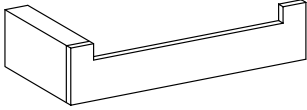
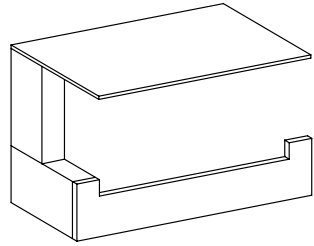

Fig. 4





Art. 20855



Art. 20849

Fig. 1

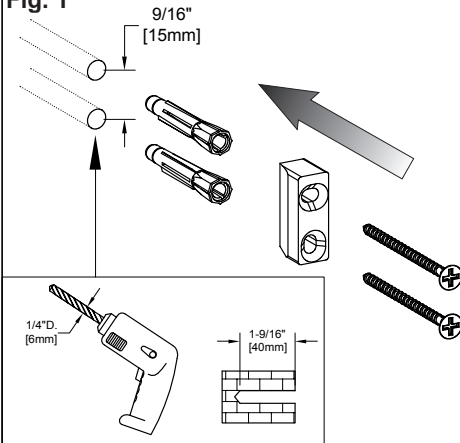

Fig. 2

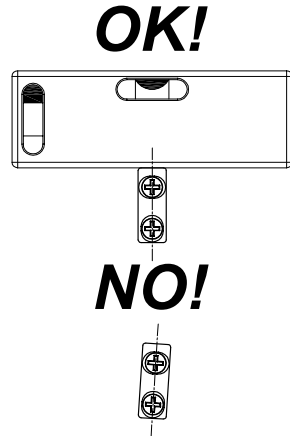

Fig. 3

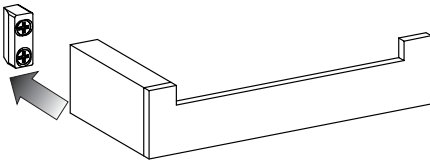
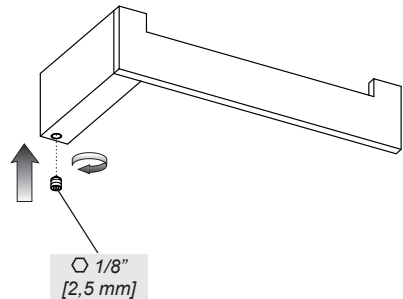
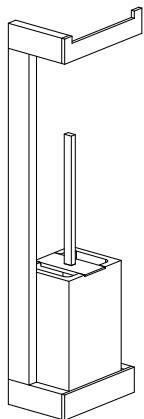

Fig. 4



INSTALLATION - INSTALLATION - INSTALACIÓN



Art. 20867
Art. 20868

Fig. 1

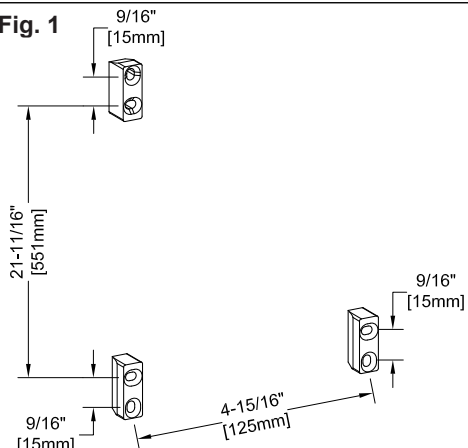

Fig. 2

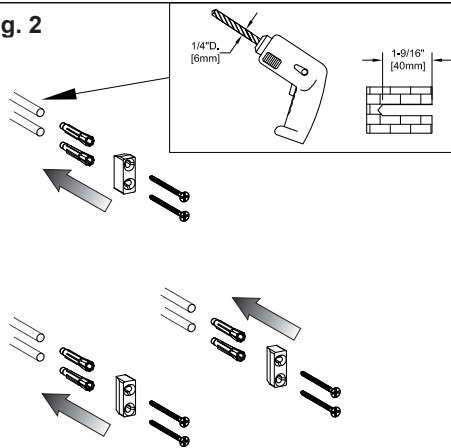

Fig. 3

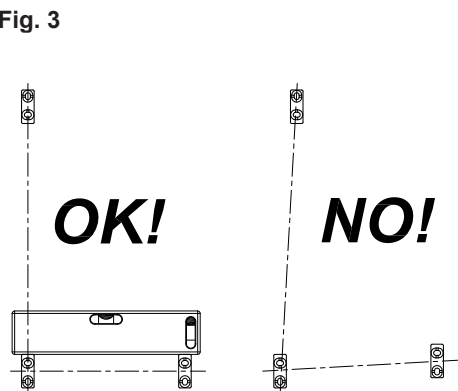
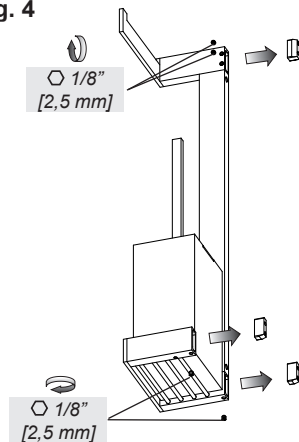

Fig. 4



Art. 20897



Art. 20900

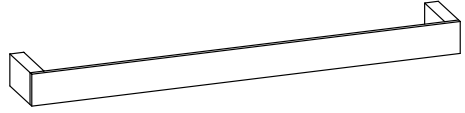

Art. 20903



Fig. 1

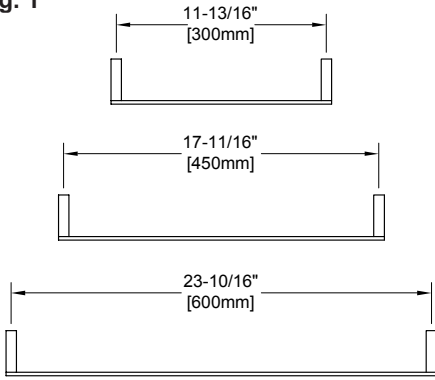

Fig. 2

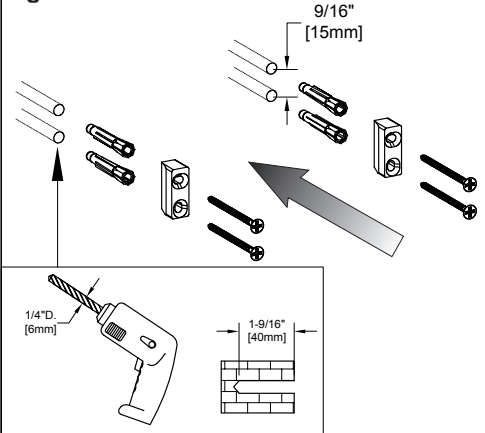

Fig. 3

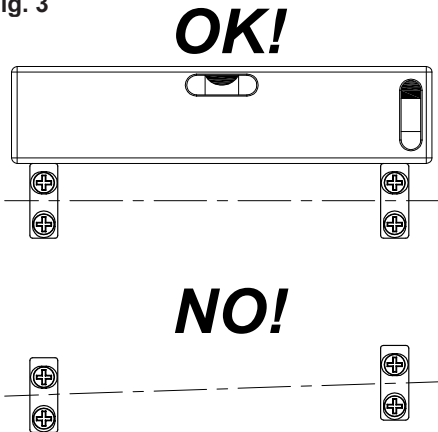
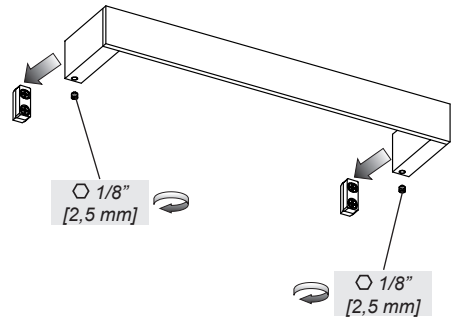

Fig. 4



Art. 20949

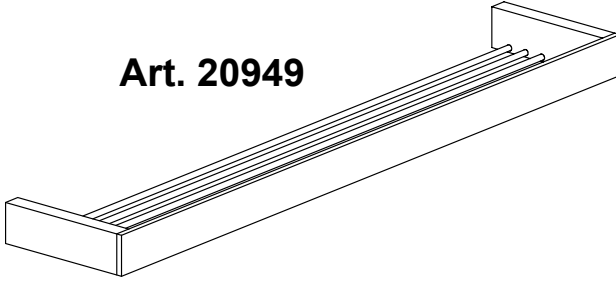

Fig. 1

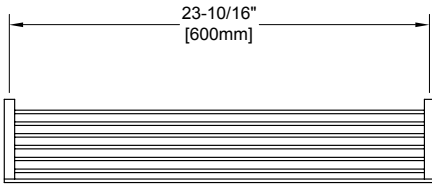

Fig. 2

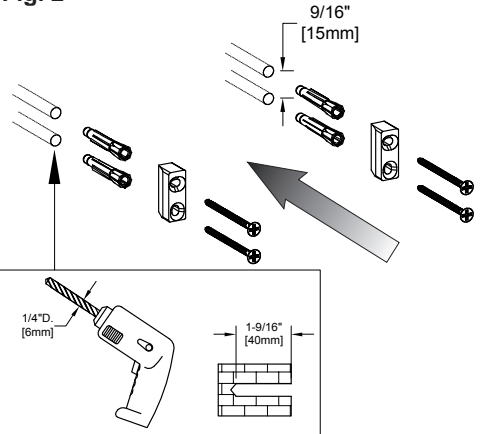

Fig. 3

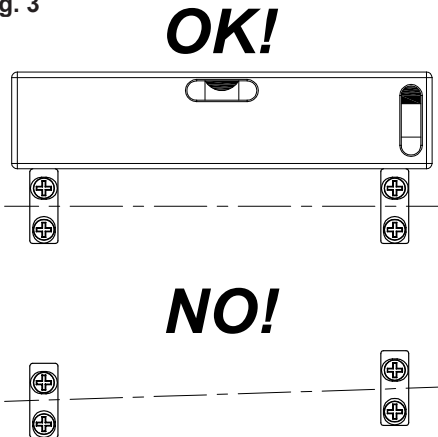
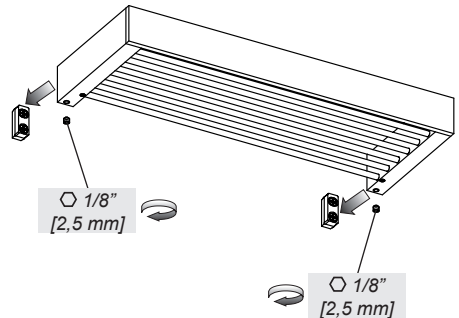
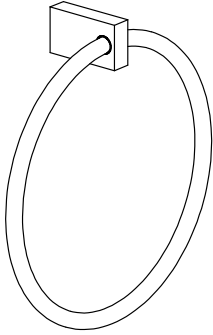

Fig. 4





Art. 20909



Art. 20921

Fig. 1

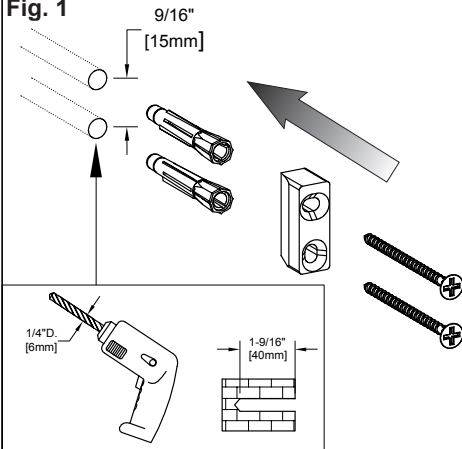

Fig. 2

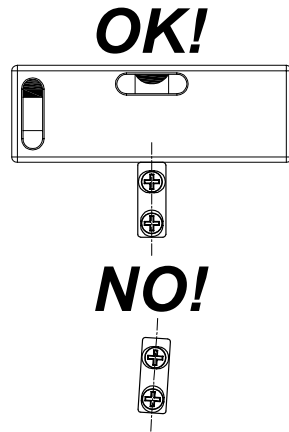

Fig. 3

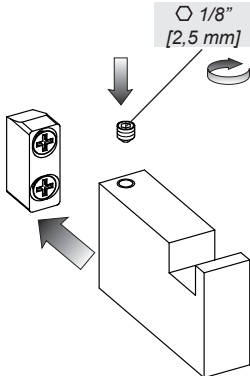
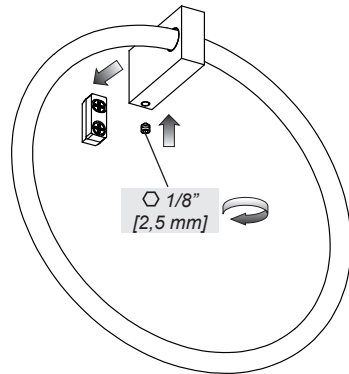
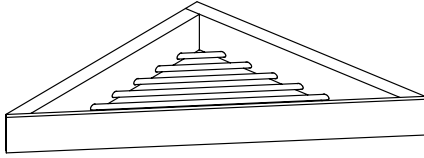

Fig. 4





Art. 20861

Fig. 1

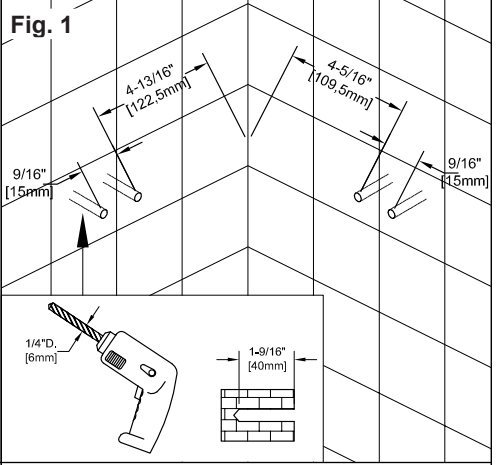

Fig. 2

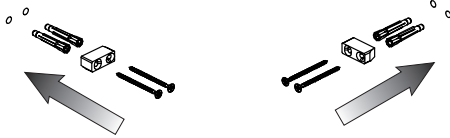
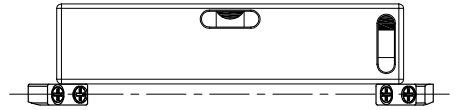

Fig. 3

OK!



NO!

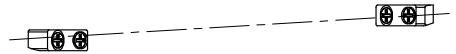

Fig. 4

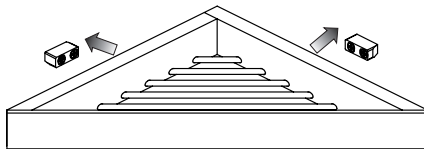

Fig. 5

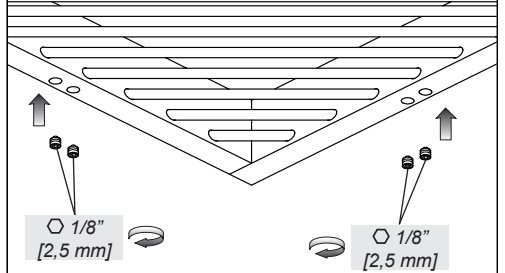

Fig. 1

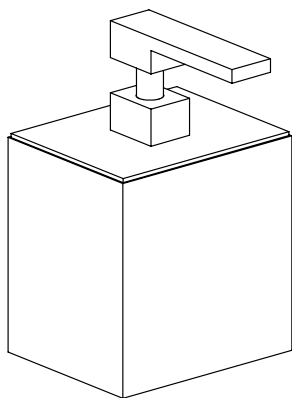

Fig. 2

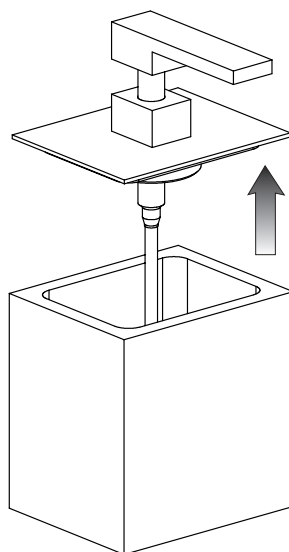

Fig. 3

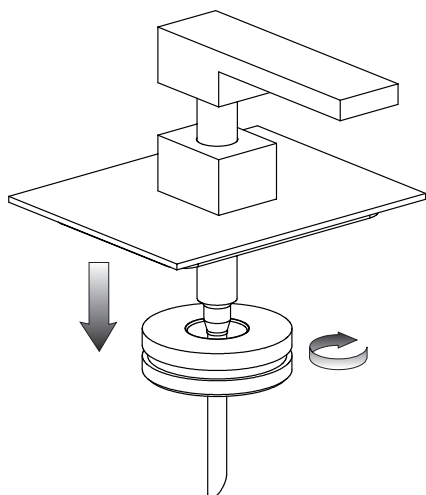

Fig. 4

