

Features

- 36-inch minimum base cabinet width.
- Double equal bowls.
- 9-inch depth.
- Five oversized faucet holes.
- Oversized holes allow for easy installation of faucets and accessories.
- Rear drain increases workspace in the sink and storage space underneath.
- Includes cutout template.

Material

- KOHLER® enameled cast iron.

Installation

- Under-mount

Recommended Products/Accessories

K-9000 P-Trap
 K-6197 Sink Rack
 K-6377 Sponge Caddy
 K-6378 Kitchen Brush Caddy
 K-6379 Kitchen Squeegee
 K-6382 Disinfecting Wipes Dispenser
 K-6383 Soap Dispenser
 K-8618 Paper Towel Holder
 K-8619 Flexible Kitchen Mat
 K-8624 Dish Scraper
 K-8801 Sink Strainer
 K-8799 Sink Strainer

Optional Products/Accessories

K-6545 Sponge Caddy

Included Components

Additional Components:
 Under-mount sink kit 23" (584 mm)



Codes/Standards

















ASME A112.19.1/CSA B45.2

KOHLER® Enameled Cast Iron Kitchen Sink Lifetime Limited Warranty

See website for detailed warranty information.

Available Colors/Finishes

Color tiles intended for reference only.

Color	Code	Description
	0	White
	FF	Sea Salt™
	96	Biscuit
	47	Almond
	FD	Cane Sugar™
	NY	Dune
	95	Ice™ Grey
	G9	Sandbar
	33	Mexican Sand™
	K4	Cashmere
	FT	Basalt
	58	Thunder™ Grey
	20	Suede
	KA	Black 'n Tan
	FP	Caviar
	7	Black Black™

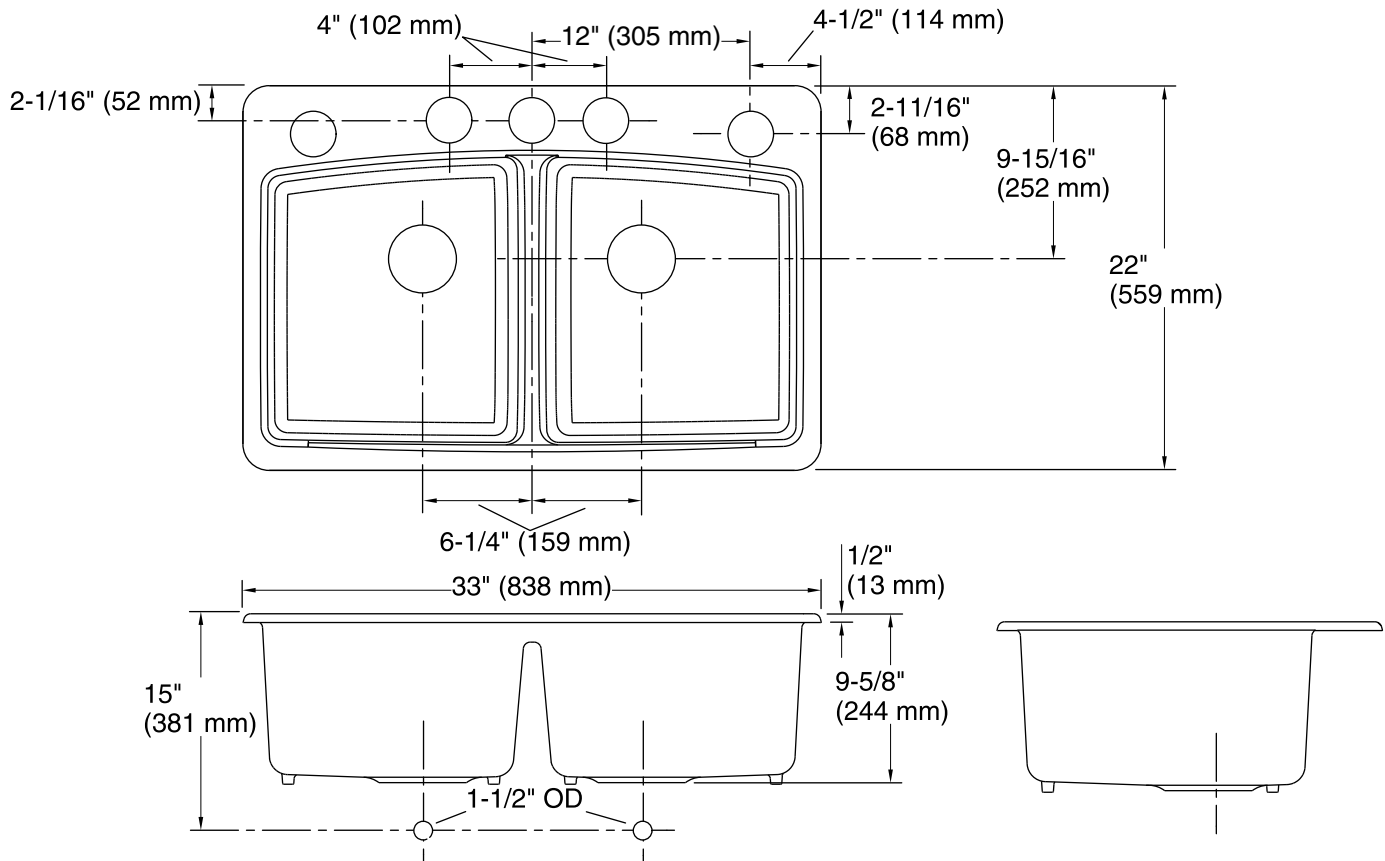

Technical Information

All product dimensions are nominal.

Bowl configuration:	Double equal
Installation:	Under-mount
Min. base cabinet width:	36" (914 mm)
Bowl area (Left):	Length: 14-3/16" (360 mm) Width: 16-1/16" (408 mm) Bowl depth: 9" (229 mm)
Bowl area (Right):	Length: 14-3/16" (360 mm) Width: 16-1/16" (408 mm) Bowl depth: 9" (229 mm)
Number of deck holes:	5
Faucet hole(s):	2-3/8" (60 mm)
Drain hole:	3-7/8" (98 mm)
Template:	1174556-7, required, included

Notes

Install this product according to the installation instructions.

NOTICE: Countertop manufacturer or cutter must use the cut-out template provided with the product, or a current one provided by Kohler Co. (call 1-800-4-KOHLER). Kohler Co. is not responsible for cutout errors when the incorrect cut-out template is used.