

# ARC MARFS-654SB

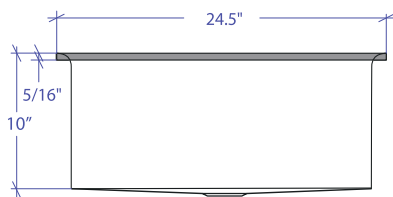

\*Flush-Mount Installation Kit is included with each sink  
\*Custom ADA compliant versions are available

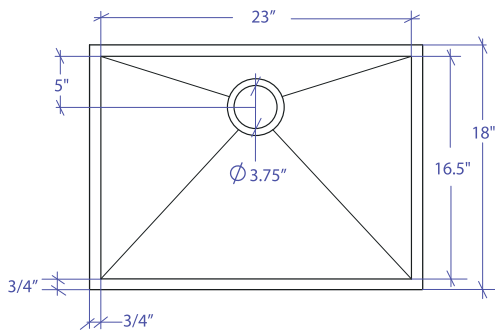

## • FEATURES

- 16-gauge type 304 stainless steel
- Hollow 304 stainless steel support beam
- 1/4" round profile basin

## • TECHNICAL INFORMATION

- External dimension: 24.5"Lx18"Wx10"D
- Basin dimensions: 23"Lx16.5"Wx10"D
- Frame width: 3/4"
- Frame thickness: 5/16"

## • FINISHES

- Satin Brushed stainless steel

## • INSTALLATION OPTIONS

- Flush-mount

## • MINIMUM CABINET SIZE (I.D.)

- Flush-mount 27.5"

## • INDUSTRY'S ONLY STAINLESS STEEL SINK DESIGNED SPECIFICALLY TO BE FLUSH-MOUNTED

## • INTERNATIONAL PATENT PENDING

## • FLUSH-MOUNT INSTALLATION

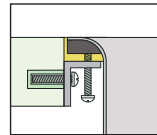

Flush-mount

## • ACCESSORIES

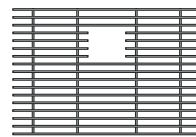

MBG-6509SB  
Basin Grid

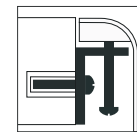

Flush Mount Kit  
(Included)  
MTK-611AL

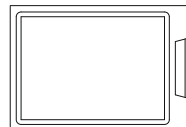

MCB-651BB  
Cutting Board

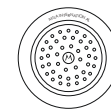

MKD-101SB  
Strainer

PROJECT INFORMATION			
Project			
Date	/ /	QTY	
Specifier			
Contact			
Note			