

# CRESCENT MCFS-656GDSB

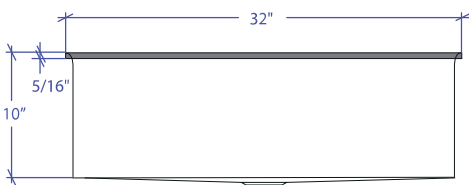

\*Flush-Mount Installation Kit is included with each sink  
\*Custom ADA compliant versions are available

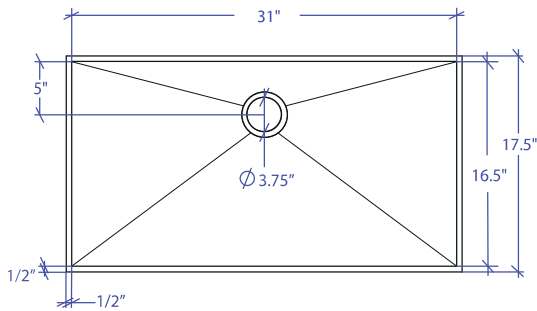

## • FEATURES

- 16-gauge type 304 stainless steel
- Hollow 304 stainless steel support beam
- 1/4" round profile basin

## • TECHNICAL INFORMATION

- External dimension: 32"Lx17.5"Wx10"D
- Basin dimensions: 31"Lx16.5"Wx10"D
- Frame width: 1/2"
- Frame thickness: 5/16"

## • FINISHES

- Gold PVD Satin Brushed stainless steel

## • INSTALLATION OPTIONS

- Flush-mount

## • MINIMUM CABINET SIZE (I.D.)

- Flush-mount 35"

## • INDUSTRY'S ONLY STAINLESS STEEL SINK DESIGNED SPECIFICALLY TO BE FLUSH-MOUNTED

## • INTERNATIONAL PATENT PENDING

## • FLUSH-MOUNT INSTALLATION

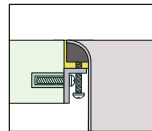

Flush-mount

## • ACCESSORIES



MBG-6514GDSB  
Basin Grid

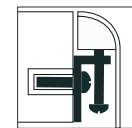

Flush Mount Kit  
**(Included)**  
MTK-619AL



MCB-651BB  
Cutting Board

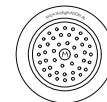

MKD-101GDSB  
Strainer



MDC-101GDSB  
Disposal Collar

PROJECT INFORMATION			
Project			
Date	/ /	QTY	
Specifier			
Contact			
Note			