

# FLATIRON MUS-805GPSB



\*Custom ADA compliant versions are available

## • FEATURES

16-gauge type 304 stainless steel  
90° zero radius design

## • TECHNICAL INFORMATION

External dimension: 27"Lx20"Wx10"D  
Basin dimensions: 25"Lx18"Wx10"D

## • FINISHES

Graphite PVD Satin Brushed stainless steel

## • INSTALLATION OPTIONS

Top-mount  
Under-mount

## • MINIMUM CABINET SIZE (I.D.)

Top-mount 28"  
Under-mount 30"

## • DUAL-MOUNT INSTALLATION

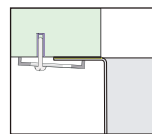

Under-mount

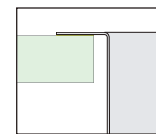

Top-mount

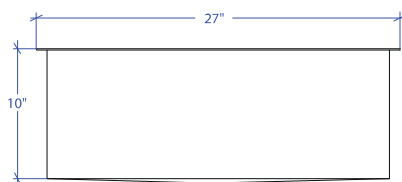
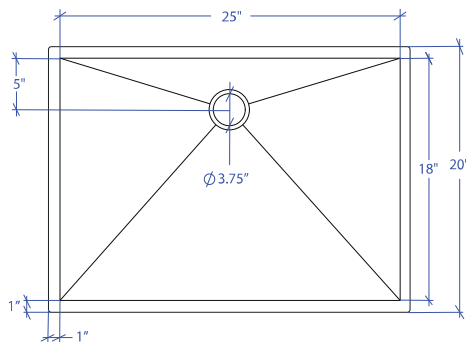

## • ACCESSORY OPTIONS

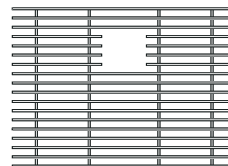

MBG-085GPSB  
Basin Grid

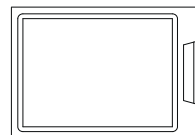

MCB-801BB  
Cutting Board

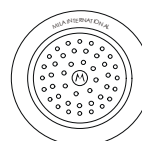

MKD-101GPSB  
Strainer

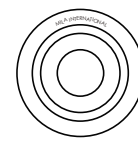

MDC-101GPSB  
Disposal Collar

PROJECT INFORMATION			
Project			
Date	/ /	QTY	
Specifier			
Contact			
Note			