

ATELIER MTD-652SB

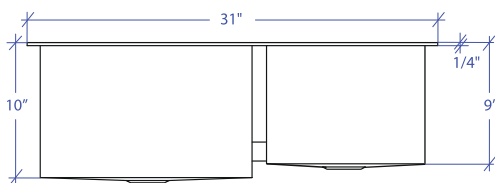

**Custom ADA compliant sinks are available*

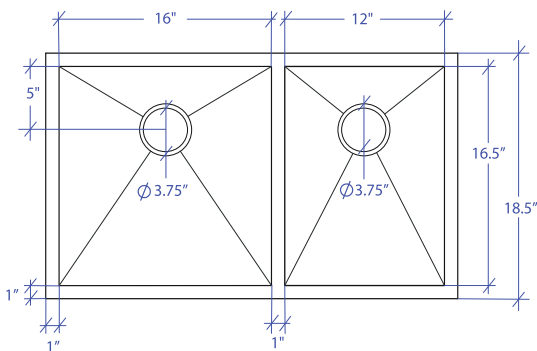

• FEATURES

16-gauge type 304 stainless steel
TRI-MOUNT™ installation system

• TECHNICAL INFORMATION

External dimension: 31" L x 18.5" W x 10" D
Basin dimensions:
Left: 16" L x 16.5" W x 10" D
Right: 12" L x 16.5" W x 9" D
Frame width: 1"
Frame thickness: 1/4"

• FINISHES

Satin Brushed stainless steel

• INSTALLATION OPTIONS

Flush-mount
Top-mount
Under-mount

• MINIMUM CABINET SIZE (I.D.)

Flush-mount 34"
Top-mount 31"
Under-mount 35"

• INDUSTRY'S ONLY STAINLESS STEEL SINK DESIGNED SPECIFICALLY TO BE FLUSH-MOUNTED

• U.S. PATENT NO. 9,988,799

• CANADIAN PATENT NO. 2579506

• TRI-MOUNT INSTALLATION

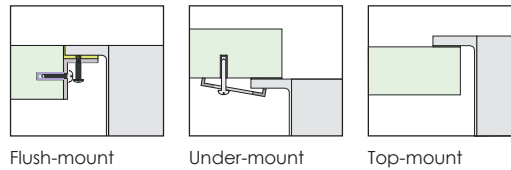

• ACCESSORIES

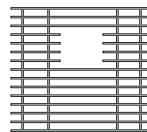

MBG-6504SB
Basin Grid

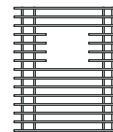

MBG-6501SB
Basin Grid

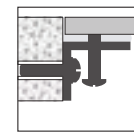

MTK-606AL
Mounting Kit

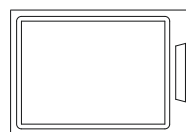

MCB-651BB
Cutting Board

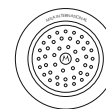

MKD-101SB
Strainer

PROJECT INFORMATION			
Project			
Date	/ /	QTY	
Specifier			
Contact			
Note			