

FLATIRON MUD-503SB

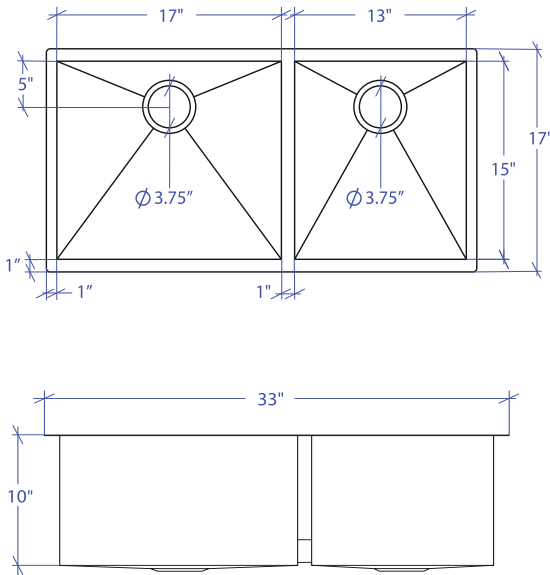

*Custom ADA compliant versions are available



• FEATURES

- 16-gauge type 304 stainless steel
- 90° zero radius design

• TECHNICAL INFORMATION

- External dimension: 33"Lx17"Wx10"D
- Basin dimensions:
- Left: 17"Lx15"Wx10"D
- Right: 13"Lx15"Wx10"D

• FINISHES

- Satin Brushed stainless steel

• INSTALLATION OPTIONS

- Top-mount
- Under-mount

• MINIMUM CABINET SIZE (I.D.)

- Top-mount 34"
- Under-mount 36"

• DUAL-MOUNT INSTALLATION

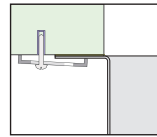

Under-mount

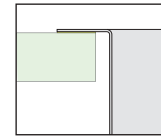

Top-mount

• ACCESSORY OPTIONS

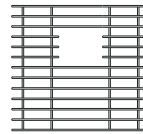

MBG-053SB
Basin Grid

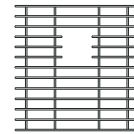

MBG-052SB
Basin Grid

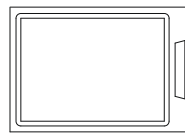

MCB-501BB
Cutting Board

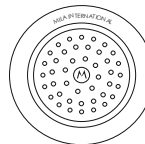

MKD-101SB
Strainer

PROJECT INFORMATION

Project			
Date	/ /	QTY	
Specifier			
Contact			
Note			