

WORKSTATION MFWS-631GDSB

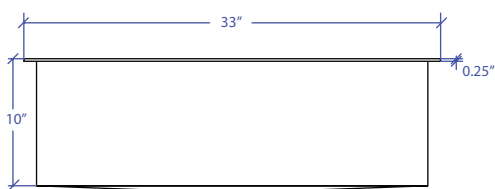

INDUSTRY'S ONLY STAINLESS STEEL SINK DESIGNED SPECIFICALLY TO BE FLUSH-MOUNTED

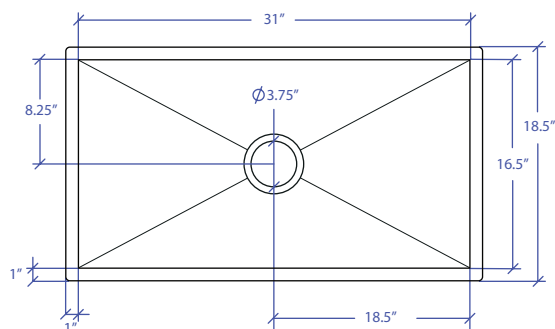

FEATURES

- 16-gauge type 304 stainless steel
- 5-gauge 304 stainless steel rim

TECHNICAL INFORMATION

- External dimension: 33" L x 18.5" W x 10" D
- Basin dimensions: 31" L x 16.5" W x 10" D
- Rim width: 1" • Rim thickness: 1/4"

FINISHES

- Gold PVD Satin Brushed stainless steel

INSTALLATION OPTIONS

- Flush-mount • Top-mount

MINIMUM CABINET SIZE (I.D.)

- Flush-mount 34"

INSTALLATION TYPE

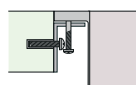

Flush-mount

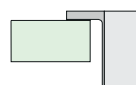

Drop-in



Included MTK-605SS
Flush Mount Kit

OPTIONAL ACCESSORIES

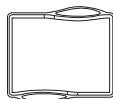

MWCB-651GDSB
Cutting Board

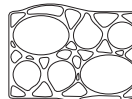

MWBM-651GDSB
Bain Marie

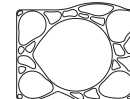

MWSM-651GDSB
Salad Mixer



MWC-651GDSB
Colander

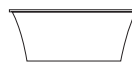

MWSS-651GDSB
Side Sink



MWRG-651GDSB
Roll up Grid

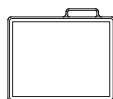

MWCBFLW-651GDSB
Cutting Board

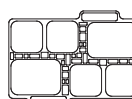

MWBMFLW-651GDSB
Bain Marie

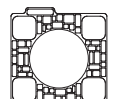

MWSMFLW-651GDSB
Salad Mixer



MWCFW-651GDSB
Colander



MWSSFLW-651GDSB
Side Sink



MWSA-651GDSB
Salad Spinner Adapter

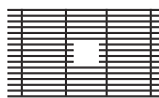

MBG-631GDSB Basin Grid



MKD-101GDSB
Strainer



MDC-101GDSB
Disposal Collar



MDC-102GDSB
Disposal Collar

US Patent No. 9,988,799 CA Patent No. 2579506
International Patent Pending

PROJECT INFORMATION			
Project			
Date	/ /	QTY	
Specifier			
Contact			
Note			