

# Genta™ Technical Specification

## 3 Piece Bath Accessory Kit

BH3633

### Stock Numbers:

- BH3633CH – 3 Piece Bath Accessory Kit**  
Chrome Finish
- BH3633BN – 3 Piece Bath Accessory Kit**  
Brushed Nickel Finish
- BH3633BL – 3 Piece Bath Accessory Kit**  
Matte Black Finish
- BH3633BZG – 3 Piece Bath Accessory Kit**  
Bronzed Gold Finish

### Materials:

Paper holder, towel ring and towel bar are constructed of zinc.

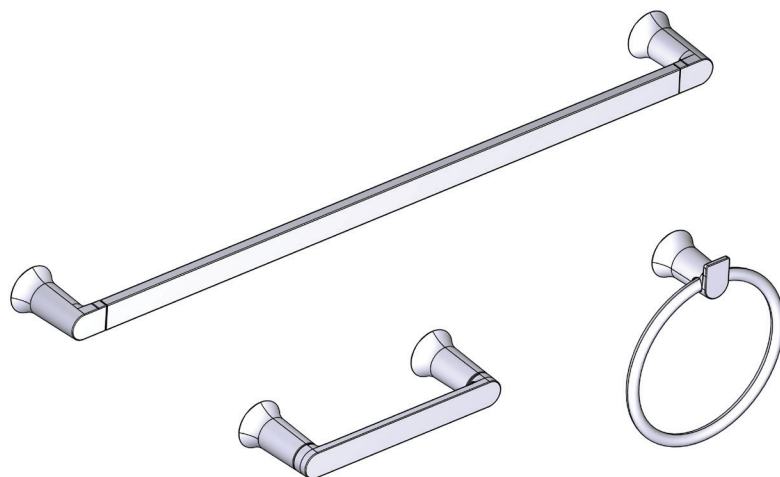

See page two for dimensions

### Installation Instructions:

Please refer to product instructions for installation steps.

### Cleaning Instructions:

To preserve the fine finish of this product, clean only with a soft damp cloth. Dry well. Do not use commercial or abrasive cleaners.

**Stock Number:** \_\_\_\_\_ **3 Piece Bath Accessory Kit**  
By MOEN

25300 AL MOEN DRIVE • NORTH OLMSTED, OH 44070  
CORPORATE HEADQUARTERS: (800) 321-8809 • FAX: (800) 848-6636  
INTERNATIONAL: (440) 962-2000 • FAX: (440) 962-2726  
CUSTOMER SERVICE (USA): (800) 882-0116 • FAX: (888) 379-2720  
WWW.MOEN.COM ©Copyright Moen, Inc.

# MOEN®

# Genta™ Technical Specification

## 3 Piece Bath Accessory Kit

BH3633

### Dimensions:

#### Paper Holder

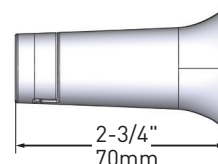
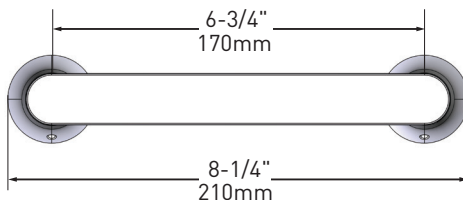
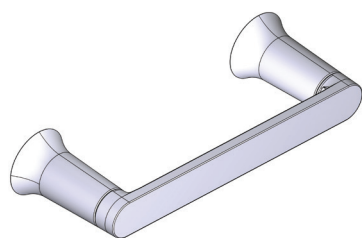

#### 24" Towel Bar

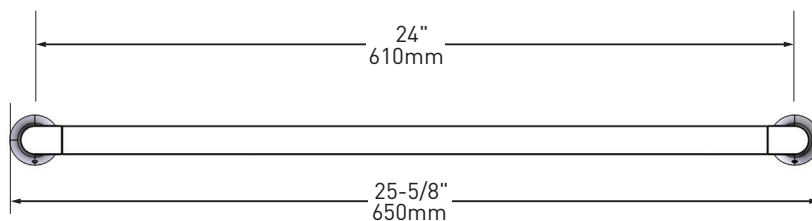
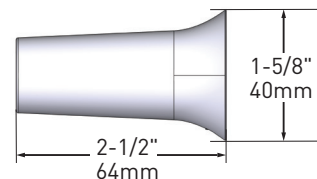
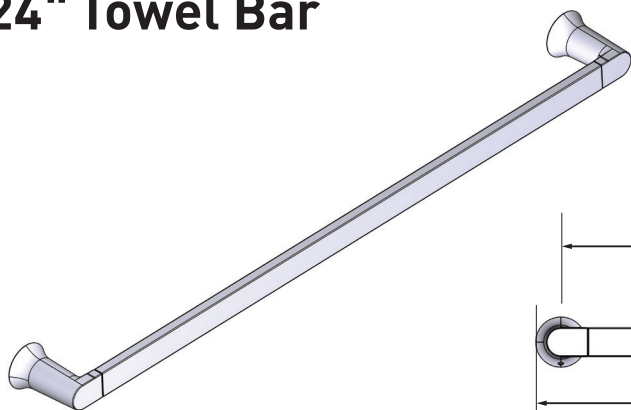

#### Towel Ring

