

## TRADITIONAL GANTRY FAUCET / 18" ARTICULATED SPOUT / 3PC. SUITE

### 4410-18-3

- Max Counter Thickness 2-3/8"
- Minimum Install Hole Size 1-3/8"

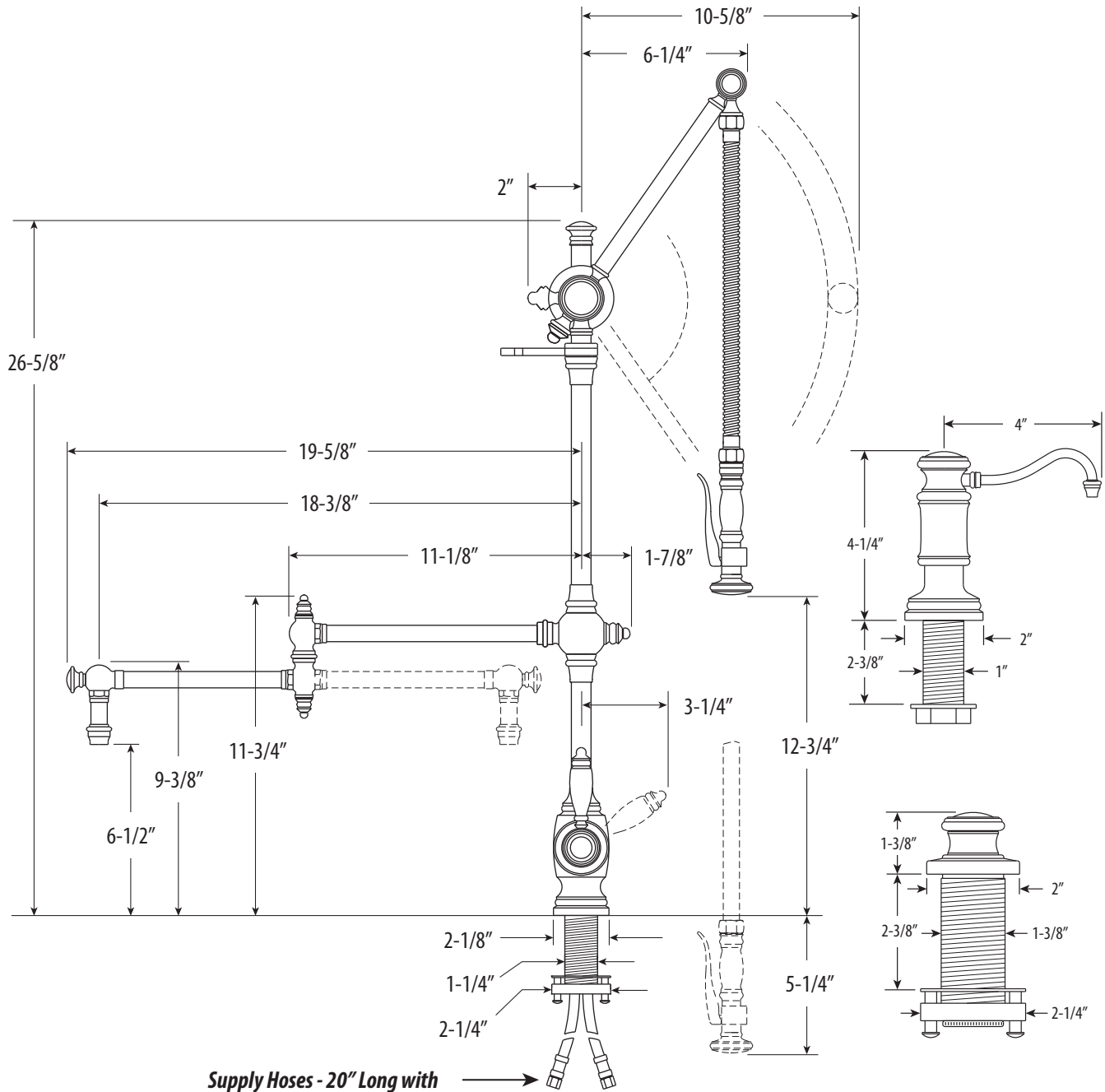

DIMENSIONS MAY VARY AND ARE SUBJECT TO CHANGE. NO RESPONSIBILITY IS ASSUMED FOR USE OF SUPERCEDED OR VOIDED DATA