



# 6 iE<sup>TM</sup>

The smartest, most efficient way to control the world's best selling floor heating

# Pack Contents

---



x1

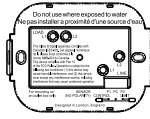

x1



x2

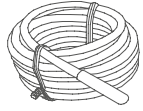

x1

# Contents

---

Safety Information .....	3
Step 1 - Installation .....	3
Step 2 - Wiring Connections .....	4
Table 1.0 - Thermostat use cases .....	5
Wiring Diagrams .....	6
Step 3 - Thermostat Mounting .....	7
Step 4 - Initial Setup .....	7
Step 5 - Add Location and Room .....	7
Welcome to the 6iE .....	8
Getting Started .....	8
How to quickly change the temperature .....	8
How to quickly change mode .....	8
Heating .....	9
How to set a program .....	9
Setback Temperature .....	9
How to set into Manual Mode .....	10
How to set into Vacation Mode .....	11
How to switch "Heating Off" .....	11
Energy Monitor .....	12
SmartGeo .....	12
Settings .....	13
Advanced Settings .....	14
Troubleshooting .....	15
WiFi Troubleshooting .....	16
Technical Specifications .....	17
Warranty .....	18

## Safety Information

---

- ❑ The 6iE must be installed by a qualified electrician. It requires a permanent 110V - 240V AC, 60Hz supply. The 6iE contains a Class A GFCI with 5mA trip level and wiring must conform to local electrical code.
- ❑ Isolate the 6iE from the mains supply throughout the installation process.
- ❑ Conduits are only required where it is mandated by state or provincial code. Please refer to local electrical code for compliant applications.
- ❑ The 6iE and its packaging are not toys; do not allow children to play with them. Small components and packaging present a risk of choking or suffocation.
- ❑ The 6iE is suitable for indoor use only. It must not be exposed to moisture, vibrations, mechanical loads or temperatures outside of its rated values.
- ❑ For safety and licensing reasons unauthorised change and/or modification of the 6iE is not permitted.
- ❑ Ensure the distance from your router to the 6iE is not excessive. This will ensure the wireless connection is not subject to range or interference issues once installed.
- ❑ Install the 6iE in an area with good ventilation. It should not be beside a window/door, in direct sunlight or above another heat generating device (e.g. radiator or TV).

## Step 1 - Installation

---

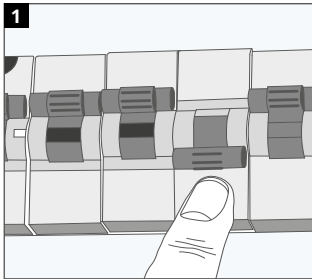

1 Isolate the 6iE and supply from the mains supply.

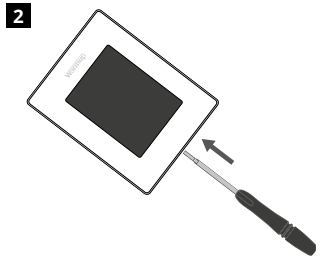

2 Unclip the display from the power base and remove the display

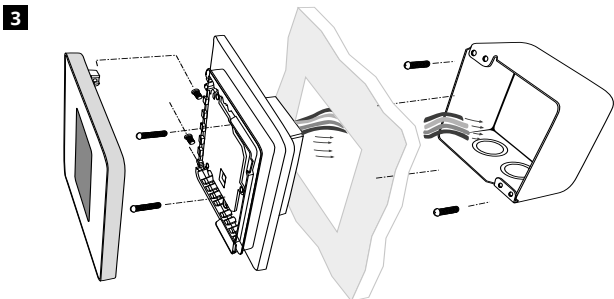

3 Install a 3-1/2" (89 mm) deep single gang or 2-gang box with mud ring in your preferred thermostat location. Pull wires (heater, supply and sensor) through gang box and complete terminal wiring.

## Step 2 - Wiring Connections

### WARNING!

The 6iE must be installed by a qualified electrician in accordance with National Electrical Code.

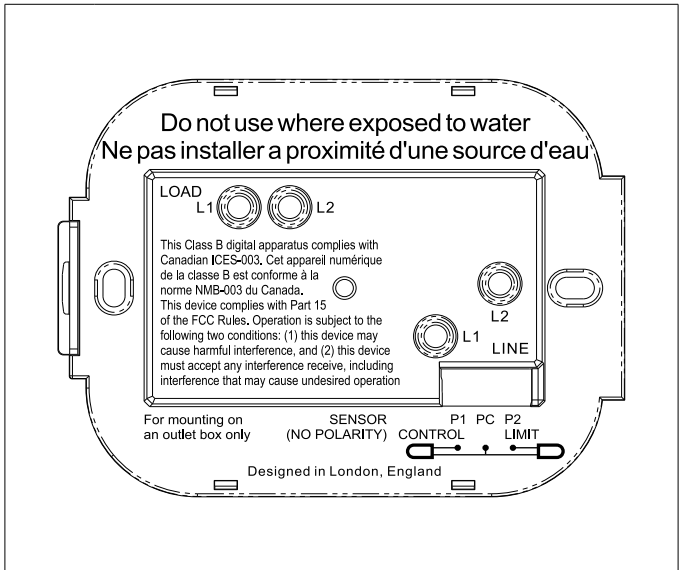

### Wiring Connections

<b>LOAD L1 &amp; L2</b>	Heater Load Max.15A (1800W - 120V, 3600W - 240V)
<b>LINE L1</b>	Supply Live (120 V)
<b>LINE L2</b>	Supply Neutral (120 V) / Supply Live (240 V)
<b>P1 &amp; PC</b>	<b>Probe 1 - Floor/Air Control Sensor (No Polarity)</b> Floor or air temperature reading for scheduled control
<b>P2 &amp; PC</b>	<b>Probe 2 - Limit Sensor (No Polarity)</b>

See Table 1.0 for thermostat use cases

**NOTE:** The function of Probe 1, Probe 2 from Control/Limit Sensor can be swapped in Advanced Settings; Sensors & Application.

**Table 1.0 - Thermostat use cases**

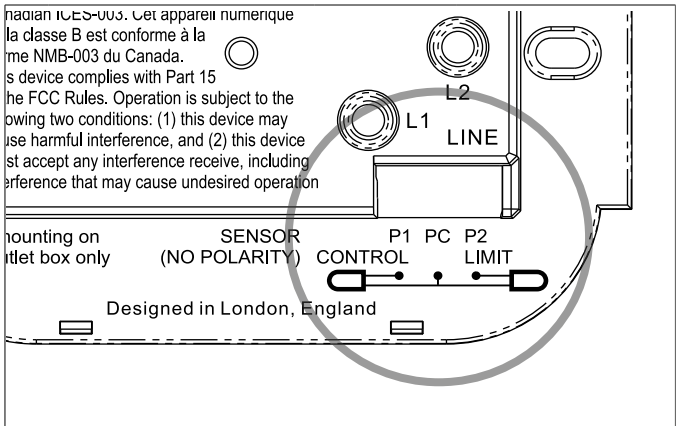

#	Use Case	Control	Limit Sensor
1	Thermostat <b>IN</b> room Air temperature schedule No floor limit	<b>Internal</b> Air Sensor	None
2*	Thermostat <b>IN/OUT</b> of room Floor temperature schedule Floor limit	<b>P1 &amp; PC</b> Floor Sensor	None
3	Thermostat <b>IN</b> room Floor temperature schedule Air limit	<b>P1 &amp; PC</b> Floor Sensor	<b>Internal</b> Air Sensor
4	Thermostat <b>OUT</b> of room Air temperature schedule No floor limit	<b>P1 &amp; PC</b> Air Sensor	None
5**	Thermostat <b>IN</b> room Air temperature schedule Floor limit	<b>Internal</b> Air Sensor	<b>P2 &amp; PC</b> Floor Limit
6	Thermostat <b>IN/OUT</b> of room Floor temperature schedule Floor limit	<b>P1 &amp; PC</b> Floor Sensor	<b>P2 &amp; PC</b> Floor Limit
7	Thermostat <b>OUT</b> of room Air temperature schedule Floor limit	<b>P1 &amp; PC</b> Air Sensor	<b>P2 &amp; PC</b> Floor Limit
8	Thermostat <b>IN/OUT</b> of room Regulator schedule No limit	<b>Reg.</b>	None
9	Thermostat <b>IN</b> room Regulator schedule Air limit	<b>Reg.</b>	<b>Internal</b> Air Sensor
10	Thermostat <b>IN/OUT</b> of room Regulator schedule No limit	<b>Reg.</b>	None
11	Thermostat <b>IN/OUT</b> of room Regulator schedule Floor limit	<b>Reg.</b>	<b>P2 &amp; PC</b> Floor Limit
12	Thermostat <b>IN/OUT</b> of room Regulator schedule Floor limit	<b>Reg.</b>	<b>P2 &amp; PC</b> Floor Limit

2\* Recommended when thermostat is **OUT** of the heated room

5\*\* Recommended when thermostat is **IN** the heated room

**NOTE:** For thermostat use cases 6 & 7 an additional sensor will be required.

## Heating Load connected to 6iE and Relay 25 - Max. 40 Amps

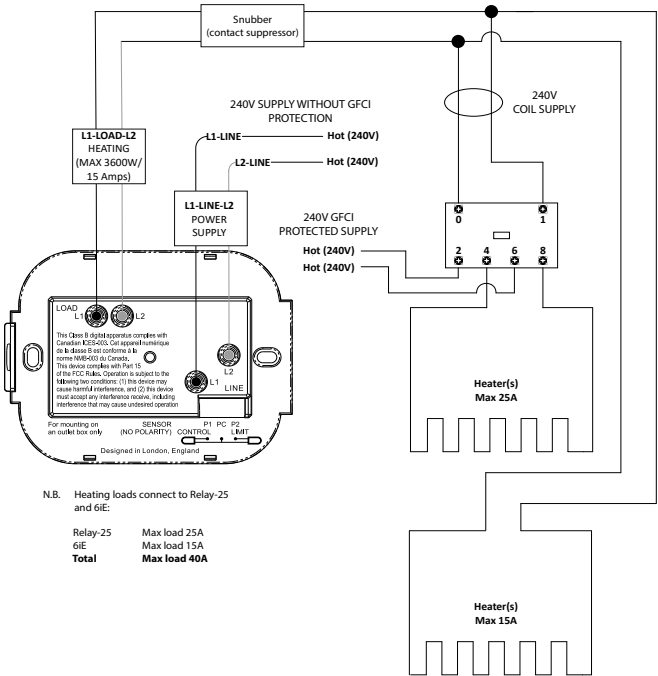

N.B. Heating loads connect to Relay-25 and 6iE:

Relay-25	Max load 25A
6iE	Max load 15A
<b>Total</b>	<b>Max load 40A</b>

## Heating Load connected to Relay 25 - Max. 25 Amps

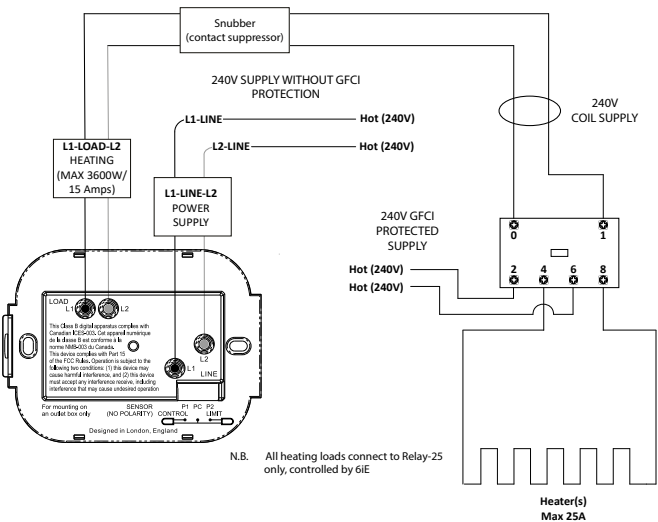

N.B. All heating loads connect to Relay-25 only, controlled by 6iE

## Step 3 - Thermostat Mounting

---

1

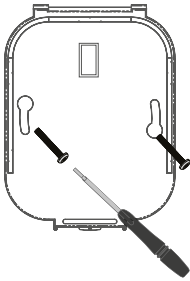

Insert fixing screws through mounting holes of the power base and tighten.

2



Re-attach the display to the power base. You can now restore power to the circuit and power up the 6iE. Follow the on screen instructions to set up the system. Once set up a QR Code will appear.

## Step 4 - Initial Setup

---

1



Download the MyHeating App.

2



Open the My Heating App and scan the QR Code on the 6iE screen. Follow the instructions in the App to complete setup.

## Step 5 - Add Location and Room

---

The MyHeating App will guide you through the setup of your 6iE. You will have to set up your house location and then the room within which your new 6iE is located.



### Location

A location needs to be setup before a room can be configured and the 6iE device registered. Creating a location is user friendly and easy to follow, it is advised to have details of your current energy tariff and pricing to hand, as these will be required if you wish to use the energy monitoring features.



### Room Setup

With a location now setup, the next step is to register a room in which your 6iE is located. This is the heating zone your thermostat will control. Ensure you set the correct System Type and Wattage of heaters connected.

**NOTE:** If an external relay or contactor relay has been installed please set System Type as Electric + Relay.

## Welcome to the 6iE

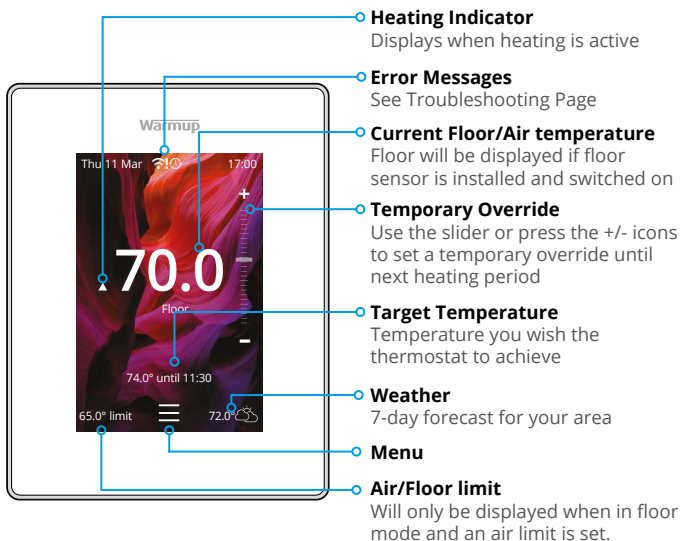

## Getting Started

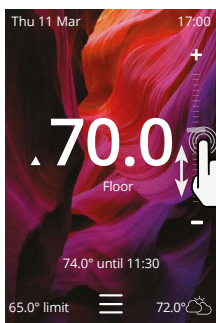

### How to quickly change the temperature

Use the slider or press the +/- icons to change your target temperature.

If in **"Program"** mode this will set a temporary override until your next heating period.

If in **"Manual"** mode this will set a fixed target temperature.

Once the target temperature is set above current floor/air temperature the heating indicator will appear.

### How to quickly change mode

Mode select allows you to quickly change from program, manual or vacation modes. You can also switch **"Frost Protection"** on or simply switch the **"Heating Off"** from here. Frost protection will ensure that the floor/air temperature does not drop below 44.0°F.

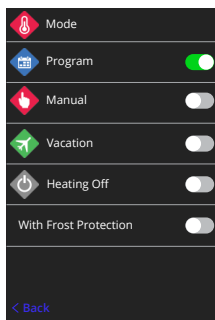
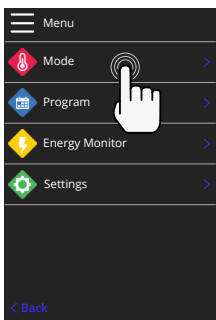
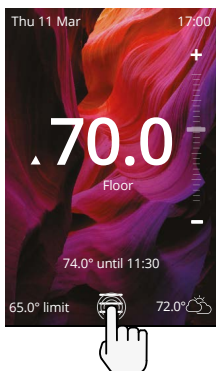



# Heating

## How to set a program

Setting a "Program" allows you to set comfort temperatures at set times throughout the day. Days can be programmed individually, all days the same or weekdays as a block and weekends as a block. The choice is yours.

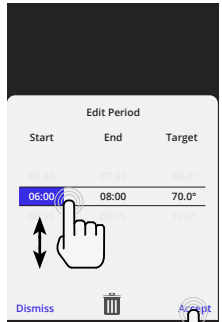
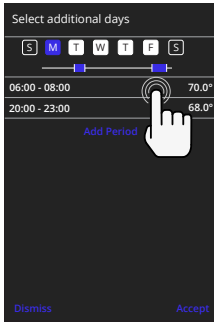
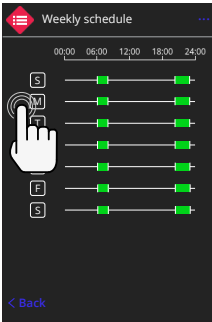
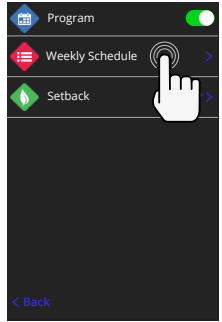
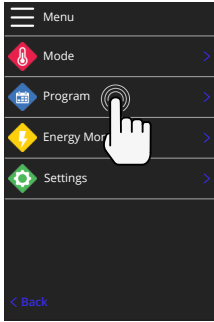
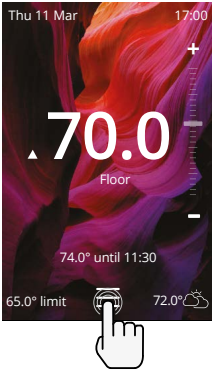

To "Select additional days" press the days of the week and the squares will be highlighted in white as shown and will follow the programmed heating schedule.

Once you are happy press "Accept" to save the heating schedule. This will return you to the previous screen to repeat as necessary.

**NOTE:** For tailor-made preset heating schedules for different room types press the three dots "...".

## Setback Temperature

The "Setback" temperature is a lower energy efficient temperature when outside of a heating period.

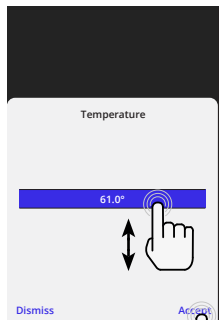
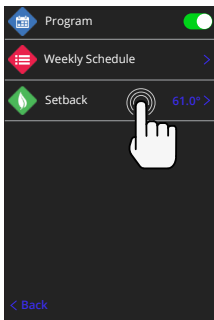

# Heating

## How to set into Manual Mode

Setting into *“Manual”* mode allows you to set a fixed target temperature for the thermostat to achieve. The thermostat will continue to maintain this temperature until another operating mode or temperature is selected.

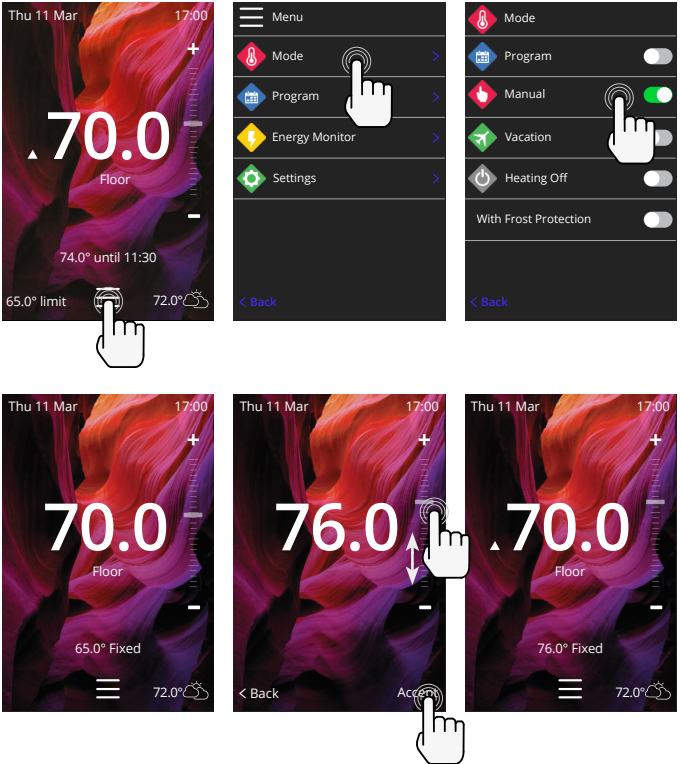

# Heating

## How to set into Vacation Mode

"Vacation Mode" allows you to override regular scheduling with a lower fixed temperature over a set time to save energy and avoid thermostat re-programming.

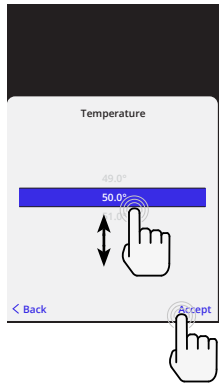
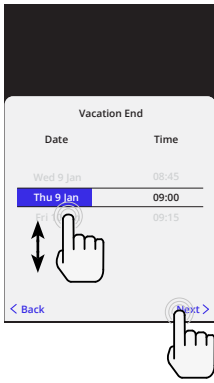
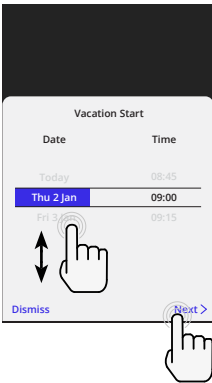
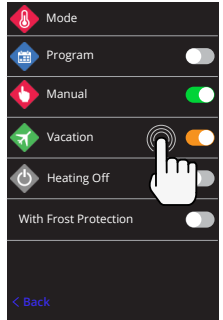
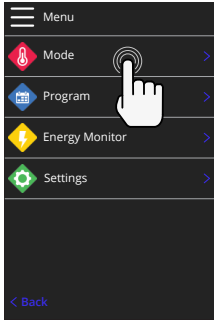
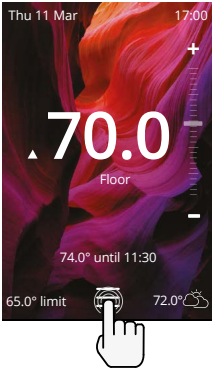

## How to switch "Heating Off"

The below will switch the heating off until you cancel it by pressing "Heating Off" on the homescreen or going into mode select and pressing the "Heating Off" slider.

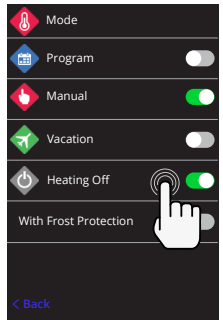
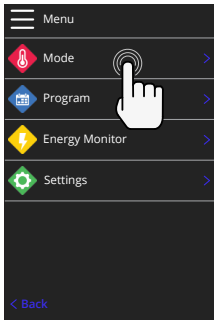
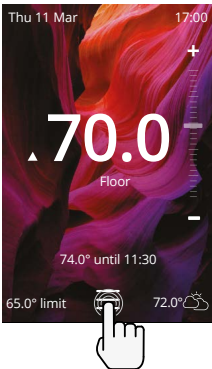

## Energy Monitor

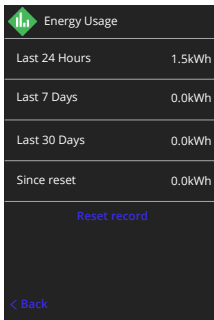

### How Energy Monitor works

The 6iE learns how you use your system and how your house reacts to heating and weather. Energy monitoring will show the amount of energy consumed over a certain time period. This will be calculated through system power (total system wattage) multiplied by efficiency and total run time.

You will need to enter the power of your system, and in some cases, the efficiency.

If you do not know these, speak to your installer or system manufacturer.

### Changing the Power Settings

If you have entered the wrong system power during setup it can be changed in Energy Monitor; Power Settings.

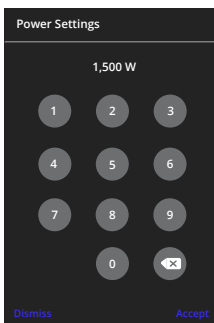

## SmartGeo

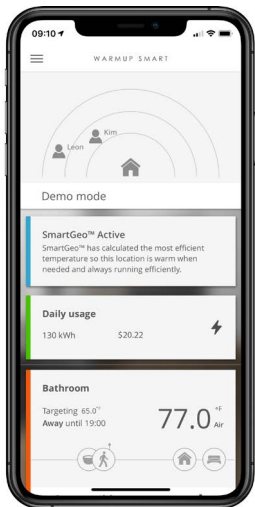

### How SmartGeo works

SmartGeo is a unique technology developed by Warmup and built into the MyHeating App that uses an advanced algorithm to understand the most efficient heat settings for your home.

Working automatically; it learns your routines and location through background communication with your smartphone and lowers temperatures when you are away, only rising them up to your ideal comfort temperature in time for your arrival home.

Smartgeo will operate when the thermostat is in the program or manual run modes. It is turned off by default. Use the MyHeating App to switch SmartGeo on.

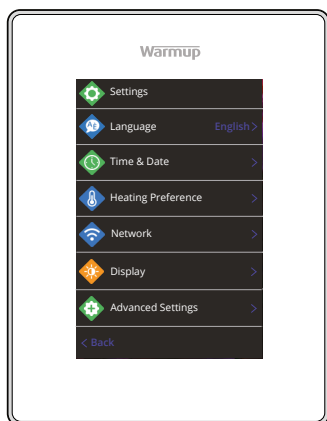

<b>Language Settings</b>	Change the 6iE language	
<b>Time &amp; Date</b>	Change the Time and Date	
	Daylight savings	<b>On/Off</b>
	24-hour time	<b>On/Off</b>
<b>Heating Preference</b>	Temperature unit	<b>°C/°F</b>
	Open window detection	<b>On/Off</b>
	<i>The windows open detection feature is designed to switch off heating to save energy when the thermostat detects that a window or door has been opened and, the outside air temperature is significantly below the indoor temperature.</i>	
	Adaptive Learning (Early Start)	<b>On/Off</b>
	<i>Adaptive learning will use the historic heating/cooling rates for the time of day, historic external temperatures and the forecast external temperatures, to work out the heating start time in order to reach the comfort time at the start of the comfort period. It will only work in Program Mode.</i>	
<b>Network</b>	WiFi Connection	<b>On/Off</b>
	<i>It is possible to set a new WiFi connection from here. The current network connection can also be viewed from this menu, including the signal strength.</i>	
<b>Display</b>	Background	<b>Light Dark Random</b>
	<i>Choose the background image of the 6iE. Random is an image selected from Warmup's collection.</i>	
	Standby style	<b>Temperature Time Minimalist</b>
	<i>Choose what will be displayed when the 6iE goes into standby. Temperature will display current temperature; Time will display the current time; Minimalist will show neither.</i>	
	Brightness	<b>Active Standby Night</b>
	<i>Adjust the brightness of the 6iE screen when in Active, Standby or Night Mode.</i>	

## Settings

Display, cont'd	Night period	Set the <b>Start</b> and <b>End</b> period
	<i>This is the time when you usually go to bed at night and wake up in the morning. The brightness of "Night" mode will begin and end using this time.</i>	
	Screen lock	<b>On/Off</b>
	<i>Locks the 6iE screen to prevent any unauthorised changes to the 6iE. Requires a 4 digit code to access the menu or make changes.</i>	

## Advanced Settings

Advanced settings	Sensors & Application	Internal Air Sensor	<b>Offset</b> +/- 10°
		Probe 1 Connected	<b>On/Off</b>
			<b>Type</b> 5, 10, 15, 100K <b>Offset</b> +/- 10°
		<i>The 6iE uses a 10K sensor. However, if using a 6iE to replace an existing thermostat you must change to the correct sensor type.</i>	
		Probe 2 Connected	<b>On/Off</b>
			<b>Type</b> 5, 10, 15, 100K <b>Offset</b> +/- 10°
		<b>Swap Probe Usage</b>	
		<i>The function of Probe 1, Probe 2 from Control/ Limit Sensor can be swapped here.</i>	
		Floor thermostat (Probe 1 On, Probe 2 Off. See Table 1.0 for alternative thermostat use cases)	<b>Control</b> Floor Remote Air Regulator <b>Limit</b> None/Air
		<i>Choose to switch the method of control for the sensor; floor sensor, remote air sensor if not installed underneath the floor or regulator mode.</i>	
		<i>Regulator Mode; Heating is on for X% out of control cycle (default 10mins). Heating is off for remaining time.</i>	
		Floor type*	<b>Tile/Stone</b> <b>Laminate</b> <b>Carpet</b> <b>Wood</b> <b>Vinyl</b> <b>Other</b>
		<i>Choose the floor type of your installation. This will apply different temperature and overheat limits to the 6iE. * Not applicable if conventional heating system was selected.</i>	

## Advanced Settings

Advanced settings	Temperature limits	Set <b>Min./Max.</b> settable temperature limits
	Overheat limit	Set <b>Overheat air</b> limit if floor sensor has been installed
	Control Period	Set between <b>10 - 60 mins.</b>
	<i>Control period checks the difference in the current measured temperature and the set temperature in a proportional integral algorithm to maintain a steady temperature.</i>	
	About	Details about the 6iE's current firmware, MAC address and WiFi connection information.

## Troubleshooting

Display is blank	Brightness	1. Check that the standby brightness is not set to Off.
	Power	2. <b>(Electrician Required)</b> Electrician required to verify power is going to the 6iE and that it is correctly wired.
ER1/ER2	Sensor Error	<p><b>(Electrician Required)</b> Electrician required to verify that the floor sensor has been wired correctly. If it is correctly wired the electrician will need to check the resistance of the floor sensor using a multi meter. For temperatures between 68°F - 86°F the resistance of the floor sensor should measure between 8K ohms and 12K ohms.</p> <p>If the electrician finds a fault, and the 6iE is in the room to be heated then it can be set into "Air Mode".</p> <p>To set into "Air Mode", go to Sensors &amp; Application in Advanced Settings and switch the probe off.</p>
Heating is coming on earlier than programmed times	Adaptive learning (Early Start) On	Adaptive learning will use the historic heating/cooling rates for the time of day, historic external temperatures and the forecast external temperatures, to work out the heating start time in order to reach the comfort time at the start of the comfort period. It will only work in Program Mode.
Cannot to set above a certain temperature	Floor Type Temperature Limits	Delicate floor coverings need to have their temperatures limited. If the finished floor is set for wood, laminate, vinyl etc. you are unable to set the temperature above 81°F.
WiFi Error Symbol	WiFi not setup	If you have not done so, download the MyHeating App, go to Settings and Network setup and follow the on screen instructions to connect to a WiFi Network.
	WiFi disconnected	<p>Follow the step above to try and to re-connect to the WiFi Network.</p> <p>If the 6iE still fails to connect, see WiFi Troubleshooting.</p>
Clock Sync Icon	Time and Date not set	Connect the 6iE to a WiFi network or alternatively set the time and date from the settings menu.

## WiFi Troubleshooting

Before following the troubleshooting guide below please check the following:

1. The password is WPA2 protected.
2. The router is set to a 2.4 GHz band. (802.11 b, g, n, b/g mixed, b/g/n mixed)

**NOTE:** If you need to change any of the items listed above, please refer to your router manual.

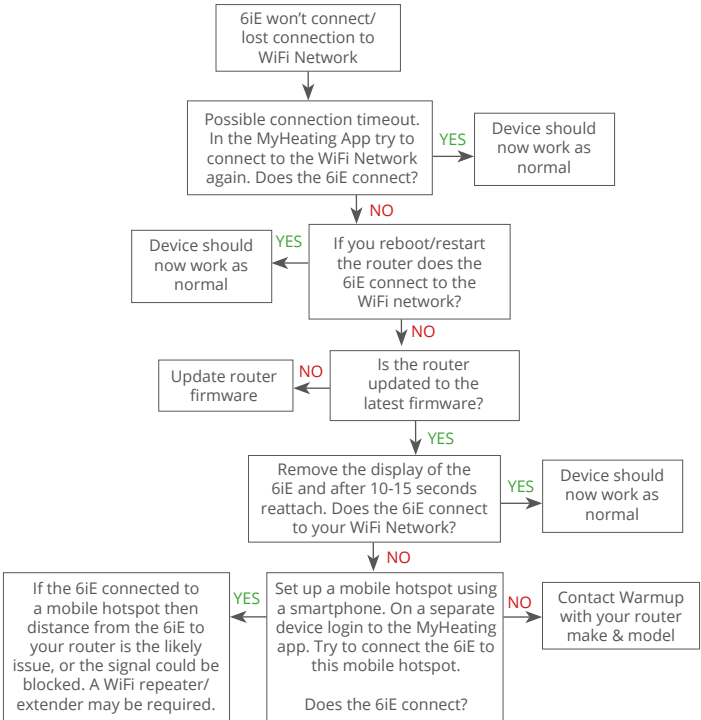



## Technical Specifications

<b>Model</b>	6IE-XX-YY-ZZ
<b>Voltage</b>	110V - 240V AC +/-15% 50Hz/60Hz
<b>Protection</b>	II 
<b>Max. Load</b>	15A resistive (120 V/1800W, 240 V 3600W)
<b>GFCI</b>	Class A GFCI with 5mA trip level
<b>Rated impulse voltage</b>	4000V
<b>Automatic action</b>	100,000
<b>Disconnection means</b>	1B
<b>Pollution degree</b>	2
<b>Max. Ambient Temperature</b>	40°C / 104°F (T40)
<b>Relative Humidity</b>	80%
<b>IP Rating</b>	IP30
<b>Sensors</b>	Floor/Air
<b>Sensor Type</b>	NTC10K @ 25°C
<b>Operating Frequency</b>	2401 - 2484MHz
<b>Max. Radio-Frequency Power Transmitted</b>	20dBm
<b>Compatibility</b>	Electric Underfloor Heating
<b>Standards</b>	UL-60730-1 UL-60730-2-9 UL-943 CAN/CSA-E60730-1 CAN/CSA-E60730-2-9 CAN/CSA-C22.2 No. 144.1 FCC 47 CFR Part 15, ICES-003
<b>Warranty</b>	12 years
<b>Approvals</b>	ETL Intertek

## Guarantee

---

Warmup plc warrants this product, to be free from defects in the workmanship or materials, under normal use and service, for a period of twelve (12) years from the date of purchase by the consumer when installed with a Warmup heater.



If at any time during the warranty period the product is determined to be defective, Warmup shall repair or replace it, at Warmup's option. If the product is defective, please either;

Return it, with a bill of sale or other dated proof of purchase, to the place from which you purchased it, or Contact Warmup. Warmup will determine whether the product should be returned or replaced.

The twelve (12) year warranty only applies if the product is registered with Warmup within 30 days after purchase. Registration can be completed online at [www.warmup.com](http://www.warmup.com)

This warranty does not cover removal or re-installation costs and shall not apply if it is shown by Warmup that the defect or malfunction was caused by failure to follow the instruction manuals, incorrect installation or damage which occurred while the product was in the possession of a consumer. Warmup's sole responsibility shall be to repair or replace the product within the terms stated above. If the 6iE is installed with a non-Warmup heater a three (3) year warranty will apply. This warranty does not extend to any associated software such as apps or portals.

WARMUP SHALL NOT BE LIABLE FOR ANY LOSS OR DAMAGE OF ANY KIND, INCLUDING ANY INCIDENTAL OR CONSEQUENTIAL DAMAGES RESULTING, DIRECTLY OR INDIRECTLY, FROM ANY BREACH OF ANY WARRANTY, EXPRESS OR IMPLIED, OR ANY OTHER FAILURE OF THIS PRODUCT. THIS WARRANTY IS THE ONLY EXPRESS WARRANTY WARMUP MAKES ON THIS PRODUCT. THE DURATION OF ANY IMPLIED WARRANTIES, INCLUDING THE WARRANTIES OF MERCHANTABILITY AND FITNESS FOR A PARTICULAR PURPOSE, IS HEREBY LIMITED TO THE TWELVE-YEAR DURATION OF THIS WARRANTY.

This Warranty does not affect your statutory rights.

# Warmup



## Warmup Inc

[www.warmup.com](http://www.warmup.com)

[us@warmup.com](mailto:us@warmup.com)

**T:** (888) 927-6333

**F:** (888) 927-4721

## Warmup Canada

[ca@warmup.com](mailto:ca@warmup.com)

**T:** (888) 592-7687

**F:** (888) 927-4721